

TROCEN[®]

Motion Control is Trocen

TL-3120 Motion Control User Manual

Laser Motion Control



2018.08

www.sztrocen.com

Copyright © 2016 Trocen Automation Tech. Co. Ltd. All Rights Reserved

Copyright

Shenzhen Trocen Automation Tech. Co. Ltd. (Hereinafter referred as Trocen) reserves the right to modify the products and product specifications in this manual without prior notice.

Trocen is not liable for any loss or liability arising directly, indirectly, specifically, incidental or consequential due to the use of this manual or this product.

The company has the patent, copyright and other intellectual property rights of the product and its software. Without authorization, it shall not directly or indirectly reproduce, manufacture, process, use this product and its related parts.



Users have the responsibility to pay attention to the design error and establish protection mechanisms. Trocen does not accept any responsibility or liability for any damage or loss resulting from improper operation.

Contact Us

Shenzhen Trocen Automation Tech. Co. Ltd.

First Floor, Building 4, Zhiheng Industrial Park, Nantou Pass Second Road,
Nanshan District, Shenzhen City, Guangdong Province, China

Tel: +86-0755-27958262

Fax: +86-0755-27447913-608

Email: qiancheng@sztrocen.com

Website: www.sztrocen.com

Introduction

Thanks for Choosing Trocen Motion Control

In order to feedback customers, we will help you to complete the production of the equipment with first-class quality motion controller, perfect after-sales service and efficient technical support.

More Information about Trocen Products

You could get more information about the company and products on our website www.sztrocen.com , including company profile, product introduction, technical support and the latest release products, etc.

You could call +86 (0755) 27958262 for more information.

Technical Support & After-Sales Service

You could contact technical support and after-sales service by the following ways:

Email: qiancheng@sztrocen.com

Tel: +86-0755-27958262

Fax: +86-0755-27447913-608

Address: First Floor, Building 4, Zhiheng Industrial Park, Nantou Pass
Second Road, Nanshan District, Shenzhen City, Guangdong
Province, China

Code: 518100

User Manual

By reading this instruction, the users will know the basic composition, installation and how to use TL-3120.

For Who

This manual is applicable to engineers who have a certain understanding of laser mechanical automation and electrical circuits.

Main Content

The composition, installation and use of TL-3120 are introduced in detail

Relevant Document

《LaserCAD User Manual》

Content

1. Product Introduction	8
1.1 System Introduction	8
1.2 Terms and Explanation	9
1.3 Unpack	9
1.4 Panel Preview	11
1.5 Buttons.....	12
1.5.1 Function Keys	12
1.5.2 Direction Keys.....	16
1.6 Wiring Board	17
1.6.1 Wiring Board Appearance.....	17
1.6.2 Port Instruction.....	18
2. LaserCAD Installation	26
3. Simplified Installation.....	27
3.1 Hardware Connection.....	27
3.2 Input Test	28
3.3 Set the Origin Point of Machine.....	28
3.4 Key Direction	29
3.5 Distance Per Pulse	30
3.6 Hard Limit and Range	31
4. Main Interface Preview	32
5. Main Page Function Introduction	34
5.1 File	34

5.1.1 Document Params Settings	34
5.1.2 Layer Params Settings	36
5.2 Count.....	38
5.3 Working Property	40
6. System Menu	42
6.1 U Disk Files	42
6.1.1 Work Files	44
6.1.2 Config Files	45
6.1.3 Upgrade Files.....	46
6.1.4 Save Current Config to U Disk	47
6.2 Origin Manage.....	47
6.3 Jog Control	49
6.4 Cut Box.....	50
6.5 Axes Control	51
6.6 Motion Parameters Settings	52
6.7 Common Parameters Settings	56
6.7.1 Work Mode.....	56
6.7.2 Common Parameters	61
6.7.3 Axis Speed Parameters	64
6.7.4 Rotate Engraving & Cutting.....	65
6.8 Language	69
6.9 System Version	69
7. Manufacture Params Settings	72

7.1 Axis Parameters	72
7.2 Laser Parameters	75
7.3 I/O Parameters	77
7.4 Auto Reset Settings	78
7.5 HardLimit Settings	79
7.6 Function Config	80
8. FQA	82
Appendix 1: Wiring Diagram of Servo Driver	83

1. Product Introduction

1.1 System Introduction

TL-3120 motion controller is a motion control system developed by Shenzhen Trocen Automation Tech co., LTD. This system is used by LaserCAD software and wiring board motion controller, which greatly improves the production efficiency and reduces the production cost.

Features of LaserCAD

- User-friendly and versatile.
- Support CorelDraw, Auto CAD and other professional drawing software.
- Support the file format: AI, PLT, DXF, SVG, PDF, NC, DST, DSB, UD5, BMP, GIF, JPG, JPEG, PNG.
- Simple graphics drawing function.
- Support Z AutoFocus function.

Features of Wiring Board

- High DSP, quick calculating and optimal algorithm.
- 4.3'' color TFT LCD display with concise operation interface.
- Optical coupler, anti-electromagnetic interface and system stability.
- Faster reading files under USB and U Disk.
- 3 axis control.

1.2 Terms and Explanation



Table1-2-1 Terms and Explanation

Term	Explanation
LaserCAD Software	LaserCAD is a complementary software with auto typesetting for laser motion control.
TFT LCD Panel LCD Panel Control Panel Panel (Mainboard)	4.3" color TFT LCD control panel. The panel is used for specific display and control operations and it is an important part of the system.
Wiring board (Baseboard)	The baseboard is the control board of the integrated signal (input and output) control and the motor drive connection.
Hardware	Includes: mainboard, wiring board, wire and so on.

1.3 Unpack

After receiving the product, please confirm whether the product and accessories are complete. If there is a lack of accessories, please contact the after-sales service of Trocen company.

Table1-3-1 Wire Introduction

Name	Appearance	Introduction
Mainboard and Wiring Board		The mainboard and wiring board of TL-3120.
USB Cable (3m)		Connect computer and panel by USB.
Extending Line (1m)		The extending line of USB.

1.4 Panel Preview

There are LCD display, soft keys and U disk slot on panel.

Figure1-4-1 Panel Preview

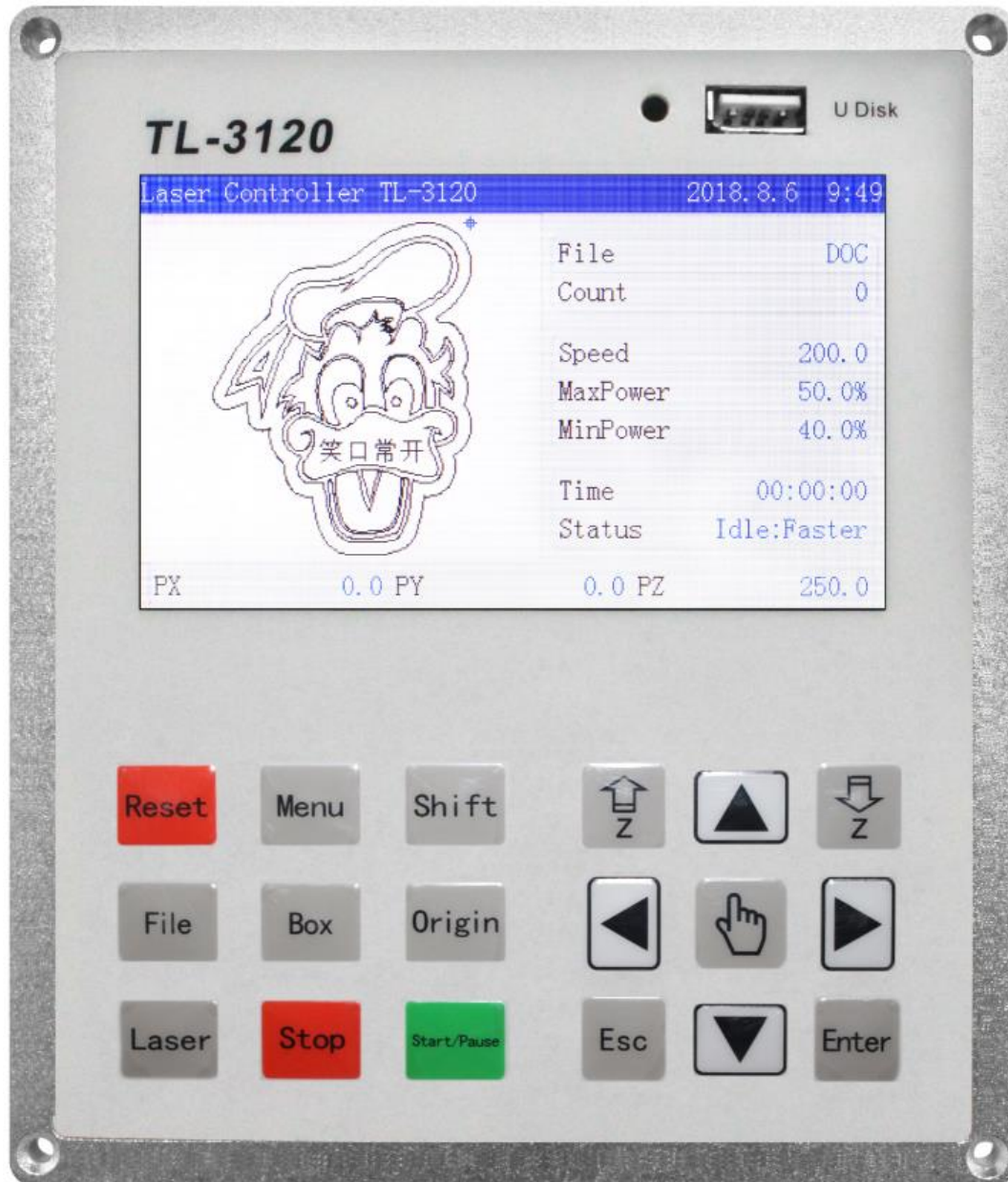
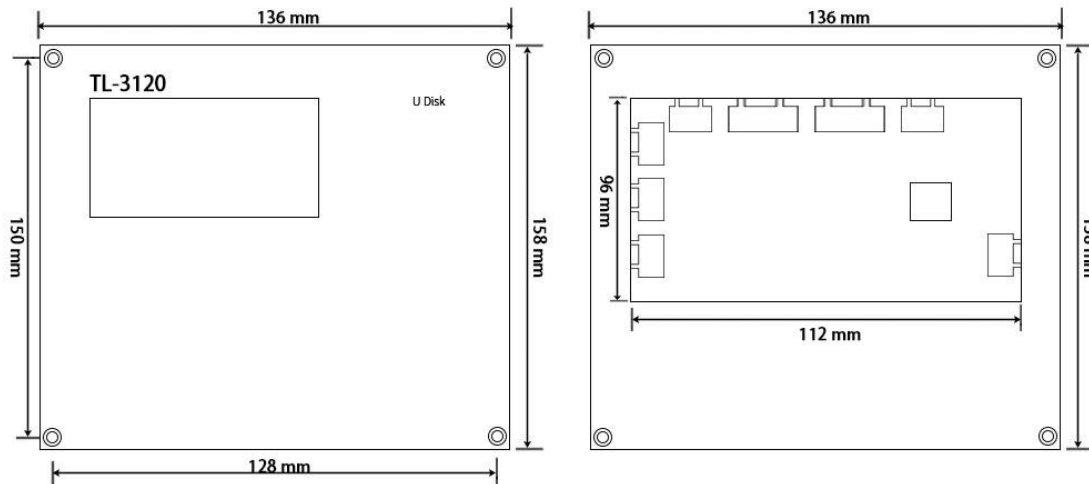

Figure1-4-2 Size of Main Board



1.5 Buttons









According to the different use of keys, all keys are roughly divided into two categories: function keys and direction keys.

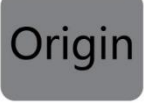
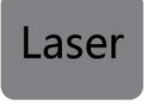

1.5.1 Function Keys

According to the different use of keys, all keys are roughly divided into two categories: function keys and direction keys.

Table1-5-1 Function Keys Instruction

Name	Icon	Instruction
Reset		No matter what state the machine is in, pressing this button will make the machine enter resetting state.

Menu		Show the main menu.
Shift		Combine function key.
File		Browse the files stored in the control board.
Box		Frames the working area from the origin point of the current file.
Origin		Setting machine's starting point of the current file.
Laser		Test usage. Press the key, the laser tube will give out light. It's used to adjust optical path.
Stop		Once pressed, the machine will stop its current function and move back to its origin. Press 【Stop】 + direction keys to switch the speed of axis movement, quick to slow or slow to quick.
Start/Pause		Pause the machine and keep it stay at location. Press again to resume.
Esc		Exit edit mode (Exit cursor). Return to previous menu.

Enter		Enter edit mode (Start cursor). Confirm the current operation.
Hand		Manually switch fast speed and slow speed of motion axis.

On the main page, press **【File】** and you could see the memory files stored in the mainboard.

Figure1-5-1 File Interface

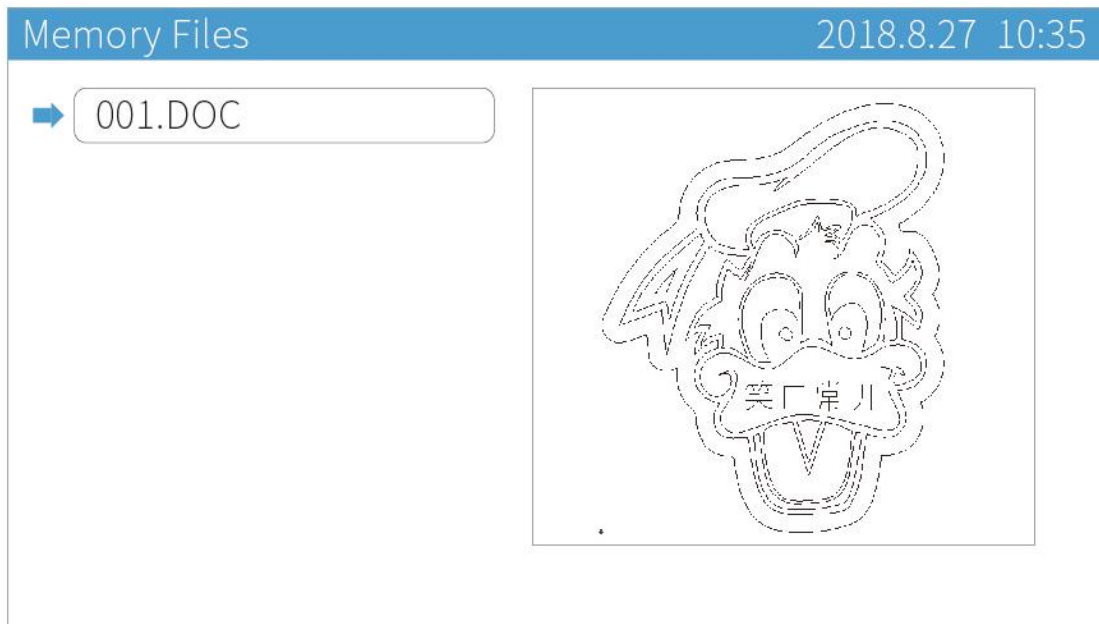

Move cursor to the file you need, press **【Enter】** , you could set the file parameters.

Figure1-5-2 File Parameters Setting Page

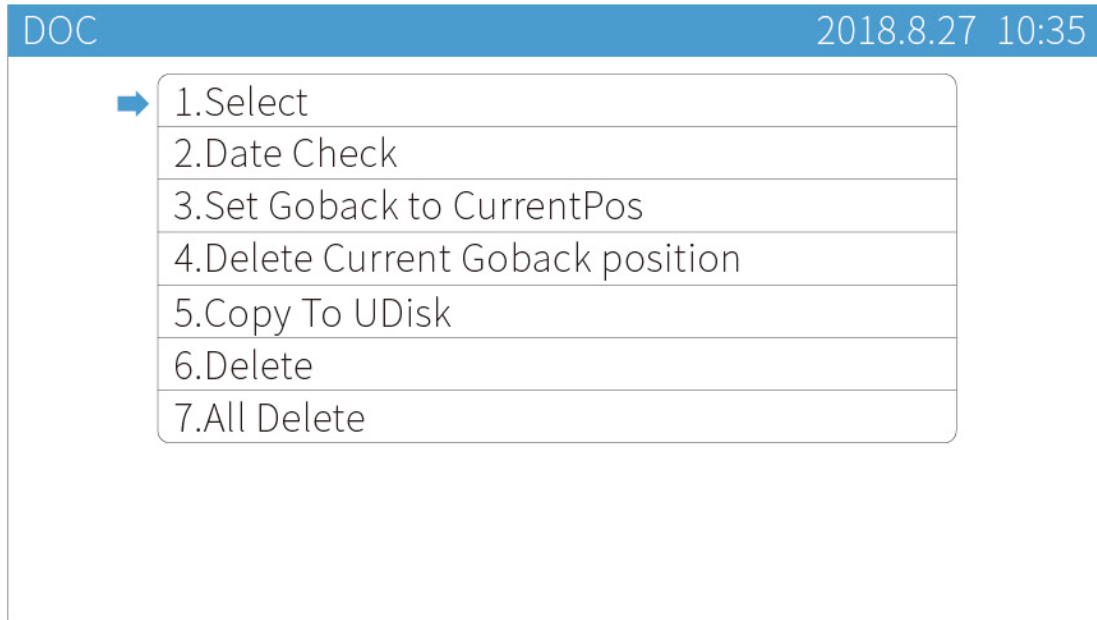

- Move cursor to **【Select】** , press **【Enter】** and set current file as work file.
- Move cursor to **【Data Check】** , press **【Enter】** . If the graphics is the same as that in PC (File Data OK!), the graphics will be allowed to process. If not, the machine won't process this graphics.

Figure 1-5-3 File Format Test



Users could set other parameters as need.

1.5.2 Direction Keys

- **【↑】【↓】【←】【→】**

They are used to move the motion axis and cursor, also used to modify options in the current view.

- **【z↑】【z↓】**

Move Z axis. When the cursor is in reverse color, they are used to modify parameters. When **【↑】【↓】【←】【→】** are busy, they are used to move cursor.

1.6 Wiring Board

The components as below:

- Connect motor driver
- Detection of motion axis limit signal
- Input signal detection
- Output IO control signal and corresponding power supply

1.6.1 Wiring Board Appearance

Figure1-6-1 Wiring Board Appearance

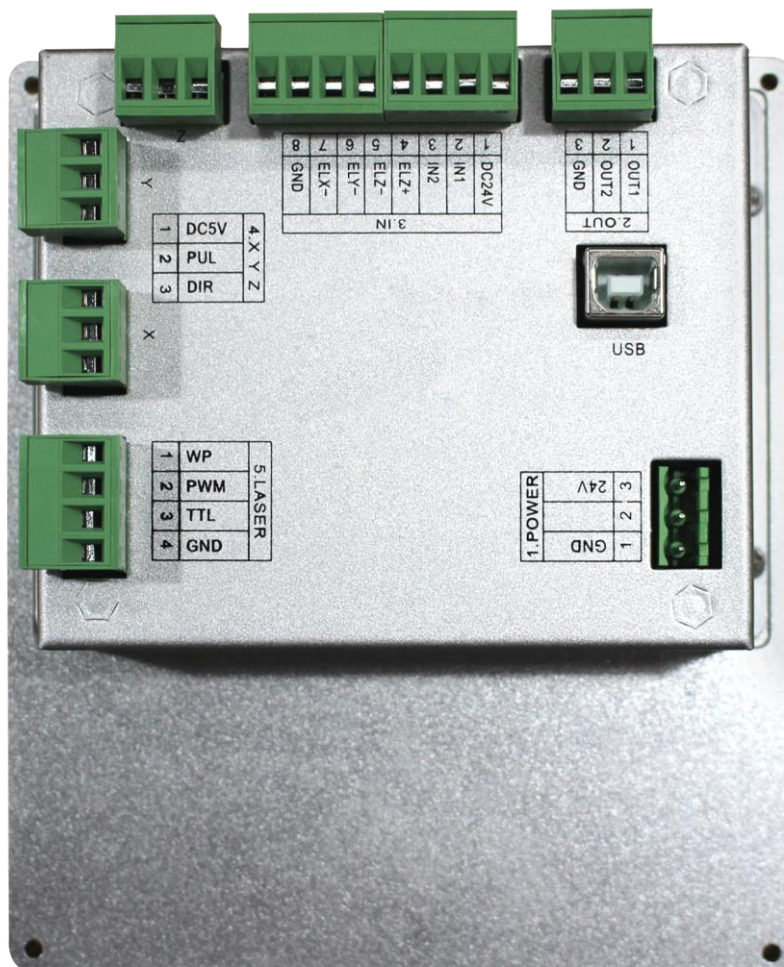

1.6.2 Port Instruction

1.6.2.1 Power Supply Port

The power supply ports provide power to wiring board and panel. Please pay more attention to polarity when connect them. Don't make the polarity reverse.

Table1-6-1 Instruction of Wiring Board Power Supply Port

Pin	Name	Introduction
1	+24V	24V positive polarity.
2	GND	Negative pole.

1.6.2.2 Signal Input

There is one group of signal input ports.

Table1-6-2 Wiring Board Signal Input Port Instruction

	PIN	Name	Instruction
3.IN	1	DC24V	Output DC voltage (24V)
	2	IN1	Door open protection signal (This function needs to be turned on in the panel to be effective).
	3	IN2	Foot switch (This function needs to be turned on in the panel to be effective).

	4	ELZ+	The hard limit of Z axis. The input signal of hard limit sensor, when Z axis moves to the maximum coordinate position.
	5	ELZ-	The origin limit of the Z axis. The input signal of origin limit sensor, when the Z axis moves to the minimum coordinate position (zero position).
	6	ELY-	The origin limit of the Y axis. The input signal of origin limit sensor, when the Y axis moves to the minimum coordinate position (zero position).
	7	ELX-	The origin limit of the X axis. The input signal of origin limit sensor, when the X axis moves to the minimum coordinate position (zero position).
	8	GND	Power ground

Wiring diagram of signal input:

Figure1-6-2 Wiring Diagram for Signal Input

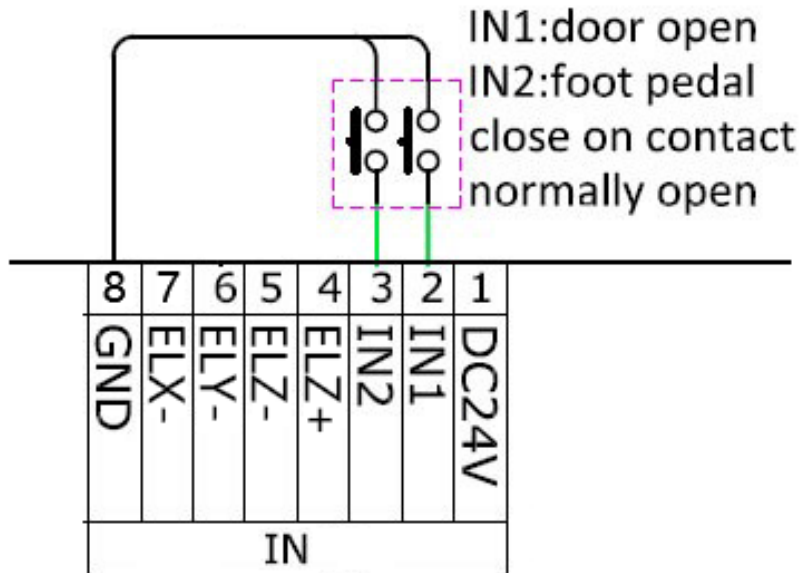

1.6.2.3 Signal Output

There is only one group of output ports to supply power and control signals. If you choose OUT2 (Blow when laser is power on), you must set the parameters of **【Blow Open Delay】** or **【Blow Close Delay】** on the **Common Parameter** interface, with the minimum value of 0.01.

Table1-6-3 Output Port Instruction

	PIN	Name	Instruction
2.OUT	1	OUT1	Blowing signal (blow all the working time): OUT1 Blowing when output is high logic level. OUT1 Do not blow when output is low logic level.

1.6.2.4 Laser Power Supply Port

The wiring board provides only one group of laser output control ports.

Table1-6-4 Laser Controller Output Instruction

	PIN	Name	Instruction
5.Laser	1	WP	Water Protection.
	2	PWM	Digital signal. The output voltage is 0~5V, and it will change according to the power.
	3	TTL	Laser switch signal.
	4	GND	Power ground.

Different lasers have different connection modes. Take ordinary glass tube laser as example. The optical signal of ordinary glass tube laser is 5V, and set low level for light emitting. The power signal PWM of main board is connected to the IN pin of laser power source and TTL to the L pin of laser power source. All signals have uniqueness, which is connected to this group of signals, other pins do not need to be connected. You could connect the water tank by the WP pin (water protection) of the main board or the P pin (water protection) of laser power supply, and please pay attention that you could only choose one of them. For the RF tube laser power supply, only connect the PWM of the main board to the IN pin, GND to G pin, and no need to connect TTL pin.

Figure1-6-4 Ordinary Glass Tube Laser Diagram

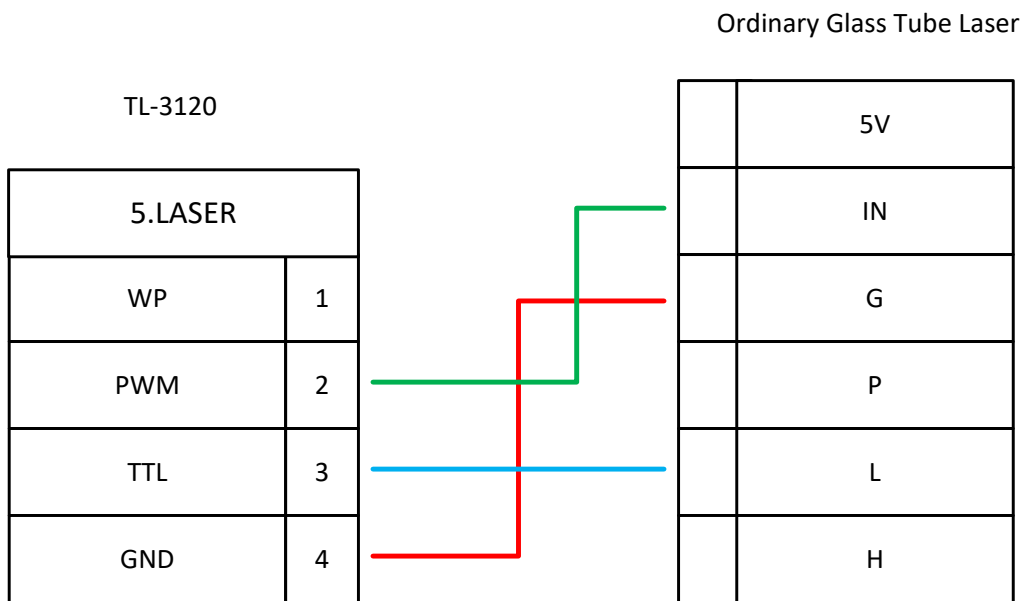
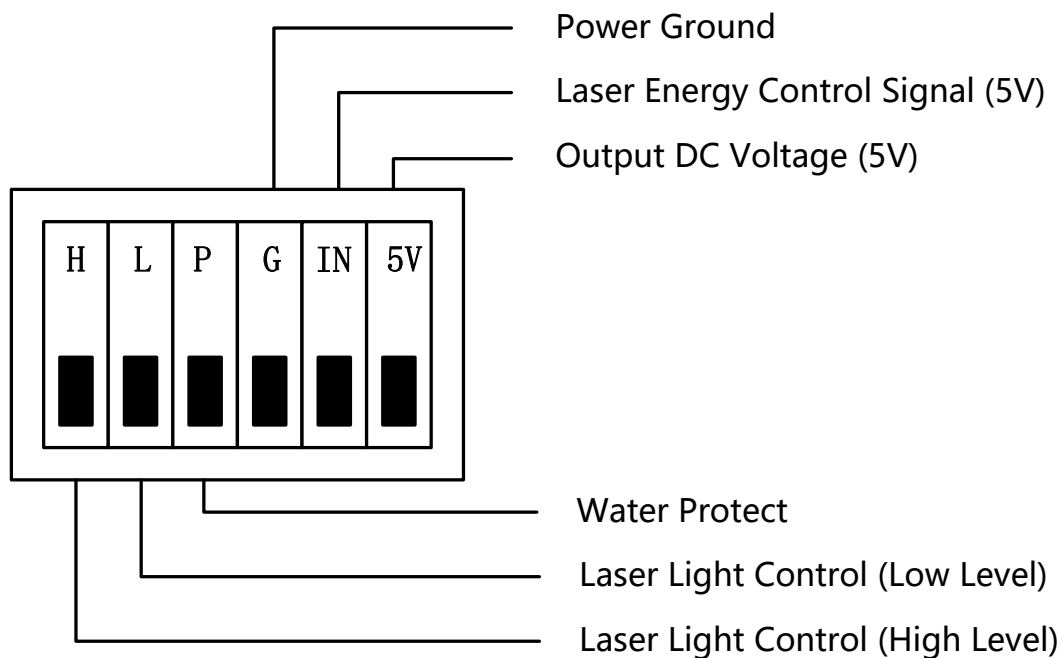

Figure1-6-5 Pins of Laser Power Source



If the laser light control signal is low level, connect the L pin of laser power,

and if the laser light control signal is high level, connect the H pin of laser power.

1.6.2.5 Motor Drive Control Port

The wiring board can provide up to 3 motor driver connections, and users can choose step driver or servo driver according to need. The servo driver has higher control accuracy than step driver. Users can choose the appropriate driving mode according to the usage scenario, cutting precision requirements and cost factors. We take the step driver as an example. [Various types of servo driver wiring diagram, please refer to Appendix 1 of this article.](#)

Table1-6-5 Motor Driver Connection Instruction

	PIN	Name	Instruction
X	1	DC5V	Output DC voltage (5V)
	2	PUL	Pulse signal
	3	DIR	Direction signal
Y	1	DC5V	Output DC voltage (5V)
	2	PUL	Pulse signal
	3	DIR	Direction signal
Z	1	DC5V	Output DC voltage (5V)
	2	PUL	Pulse signal

	3	DIR	Direction signal
--	---	-----	------------------

The diagram below shows the connection of step driver.

Figure1-6-6 Diagram of Driver Connection

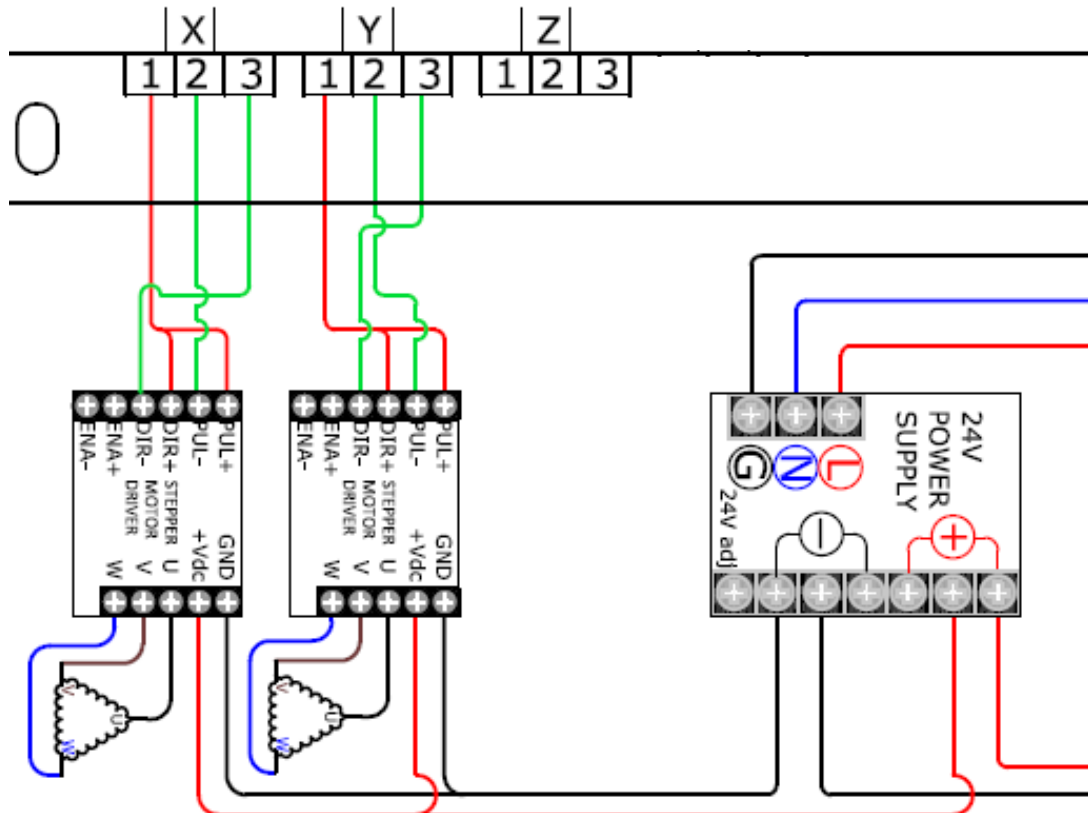

2. LaserCAD Installation

You can go through 《LaserCAD User Manual》 for more details about installation and how-to-use LaserCAD.

3. Simplified Installation

The content of this chapter is mainly about the hardware initial installation of the product and the setting of basic software parameters. Please refer to the following chapters for the detail settings and descriptions of other parameters.

3.1 Hardware Connection

Figure3-1-1 Integral Wiring Diagram

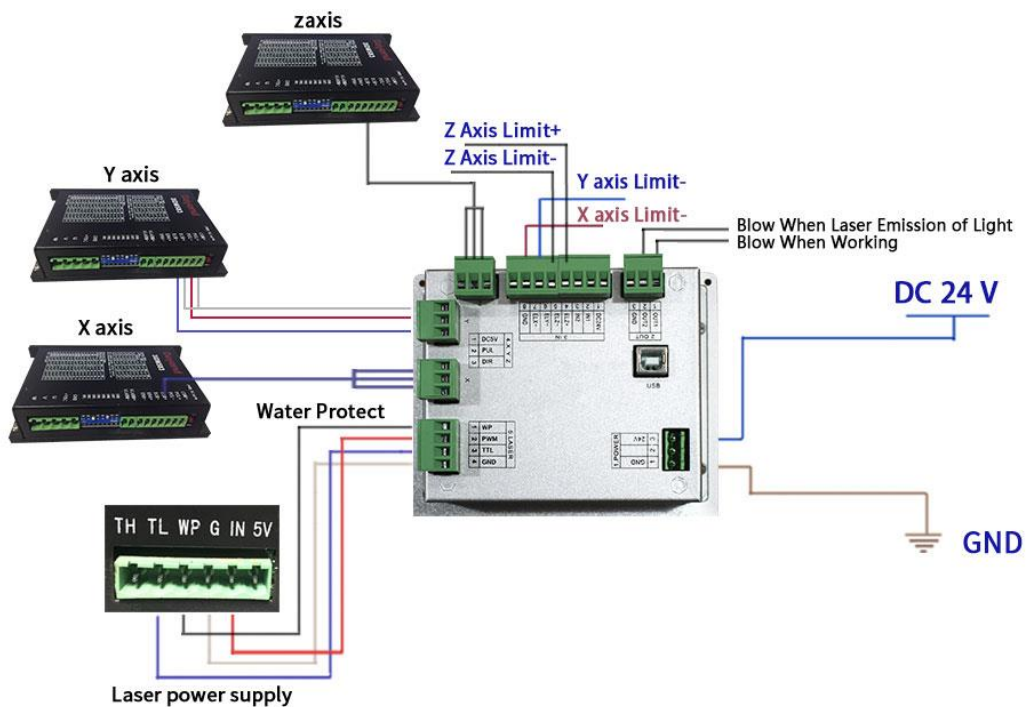

- Figure 3-1-1 shows the diagram of ordinary glass tube laser.
- Connect blow control ports to the corresponding electromagnetic valves to control blow.
- Connect the axis limit ports to corresponding axis limiters.

- Please [refer to the Chapter 1.6.2.5](#) to know more detail about X/Y/Z motor driver connection.

3.2 Input Test

On the main page, press **【Stop】** and press **【Menu】** two times at the same time, you will see the ***Input Test*** interface.

Figure3-2-1 Input Test Interface

Input		2018.8.27 10:35	
X-Limit	1	W+Limit	0
X+Limit	1	IN1	1
Y-Limit	1	IN2	1
Y+Limit	1	IN3	1
Z-Limit	1	IN4	1
Z+Limit	1	WP 1	1
V-Limit	1	WP 2	1
V+Limit	0	WP 3	1
W-Limit	1	WP 4	1

According to different types of sensors, you could choose metal products or other shielding objects to close to the sensors in order to detect whether the signals changes, so as to confirm whether the wiring is accurate and effective.

3.3 Set the Origin Point of Machine

Connect machine and wiring board as Figure3-1-1. Power on and observe

the motion of axis. If the axis moves random, please press **【Stop】** at once. Check your installation and wiring of limiters, if no mistake, then modify the direction of origin point and reset machine.

On the main page, press **【Stop】** and **【Shift】** at the same time to enter the **Manufacture Parameters Settings** page. Users could set axis parameters (Datum direction/Key direction/Limit Polarity and so on) on the **Axis Parameters** page.

Figure3-3-1 Axis Parameters Interface

X Axis Parameters		2018.8.27 10:35
➔	Distance Per Pulse (um) ...	06.500000
	Valid Pulse Edge	Falling Edge
	Datum Direction	Negative
	Key Direction	Negative
	Limit Polarity	Negative
	Range (mm)	00500
	Start Speed (mm/s)	15.0
	Max Acc (mm/s ²)	10000
	Max Speed (mm/s)	0500.0

Reset the machine, and observe the motion direction of axis again. Before start, please make sure to enable the axis auto reset function. [Detail settings refer to Chapter 7.4.](#)

3.4 Key Direction

On the main page, press **【↑】【↓】【←】【→】** to move motion axis, and

check whether the motion direction is the same as key direction. If not, please modify the **【Key Direction】** on the axis parameters page.

3.5 Distance Per Pulse

Distance per pulse refers to the actual distance of motion axis for each pulse instruction sent by the controller. The calculation method is as follows (take the X-axis as an example).

- 1) Open the **【XY AutoReset】** function, and reset machine, then mark the current position of laser head with A.
- 2) On the main page, press **【Menu】** and enter the ***Jog Control*** page. Set the **【Jog Distance】** to 200mm as example. Then press **【Enter】** to save your modification. If you did not set the **【Range】** on ***Axis Parameters*** page, please do not set the **【Jog Distance】** value too large.
- 3) On the ***Jog Control*** page, move cursor to **【X/Y Jog】** , then press direction key (**【←】** / **【→】**) one time to make the laser head move a jog distance on the X direction. Mark the current position of laser head with B.
- 4) Measure the distance between A and B, then input the value into **【Actual Length】** .
- 5) On the main page, press **【Stop】** + **【Shift】** at the same time to open the ***Manufacture Params Settings*** page. Then move cursor to **【Axis Parameters】** option and press **【Enter】** . Then open the ***X Axis Parameters*** page and move cursor to **【Distance Per Pulse】** , press

【Enter】. Input 200mm into【Expected Length】and input the distance between A and B into 【Actual Length】. Then press 【Enter】 , the distance per pulse of X axis will be calculated.

- 6) The calculation methods of distance per pulses of Y and Z axis are the same as X axis.



When the pulse distance value of any axis is close to or less than 1, the pulse distance can't be adjusted and is always 1. Users need to adjust pulse of motor driver first, then measure the distance per pulse again. The recommended pulse distance value is 5 or more.

3.6 Hard Limit and Range

On the main page, press 【Stop】 + 【Shift】 at the same time to open the **Manufacture Params Settings** page. Then move cursor to 【HardLimit Settings】 and press 【Enter】 , users can enable or disable the hard limit parameters. TL-3120 supports range function, so users do not need to install hard limit sensors, just setting 【Range】 parameters on the relevant axis parameters page will be enough.

Set the distance per pulse of X/Y/Z axis according to the content of the Chapter 3.5. Then move motion axis to the maximum distance towards positive direction. You can set the coordinate value on the panel as 【Range】 .

4. Main Interface Preview

Figure4-1 Main Interface

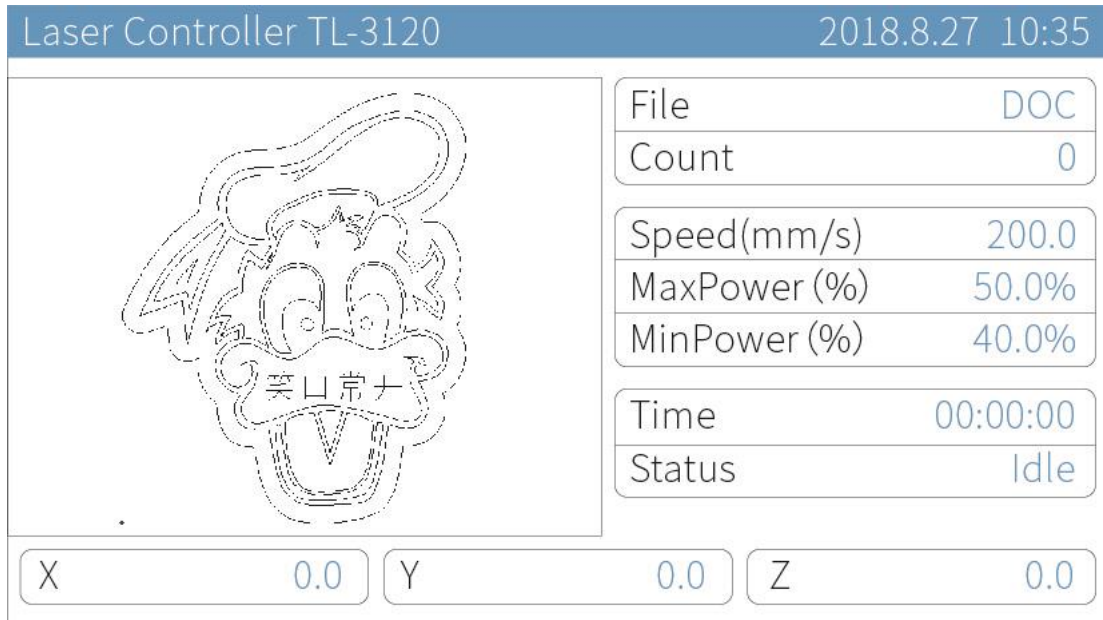

	<p>Speed/Power/Time/Status: Work: Working parameters; Idle: Laser power.</p>
--	--

Table4-1 Main Interface Introduce

Name	Instruction
Top Bar	Display the type of control card, local date and time.
File	Display the file name currently being processed.
Count	Current counts.
Speed (mm/s)	Displays working speed (Related to work state).

<p>Max Power%</p> <p>Min Power%</p>	<p>Displays the Max & Min power. Max power means working power. Min power means turning power. During cutting process, if the cutting lines is uneven (different cutting depth), the maximum and minimum power should be adjusted to ensure the best cutting effect. If the maximum and minimum power is set too high, the cutting material may be damaged. If set too low, may cause incomplete cutting. Users shall set appropriate maximum and minimum power values according to different cutting materials.</p>
<p>Time</p>	<p>Displays the amount of time worked with this task.</p>
<p>Status</p>	<p>Displays the machine state. Includes working state, idle state, pause state. There will be a percentage to show the working process of the current file under working state.</p>
<p>X/Y/Z</p>	<p>Displays the X/Y/Z coordinate in the working state.</p>

5. Main Page Function Introduction

5.1 File

5.1.1 Document Params Settings

On the main page, press **【Enter】** to make the file name highlighted as shown below. Then press **【Enter】** to open ***Document Params Settings*** interface.

Figure5-1-1 Select File Name

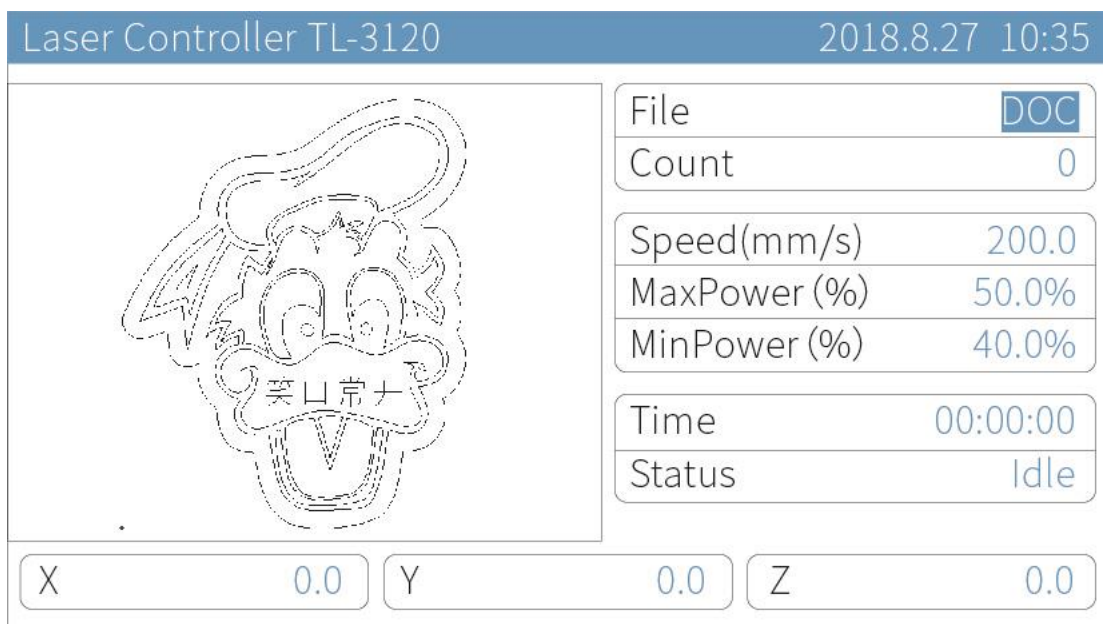
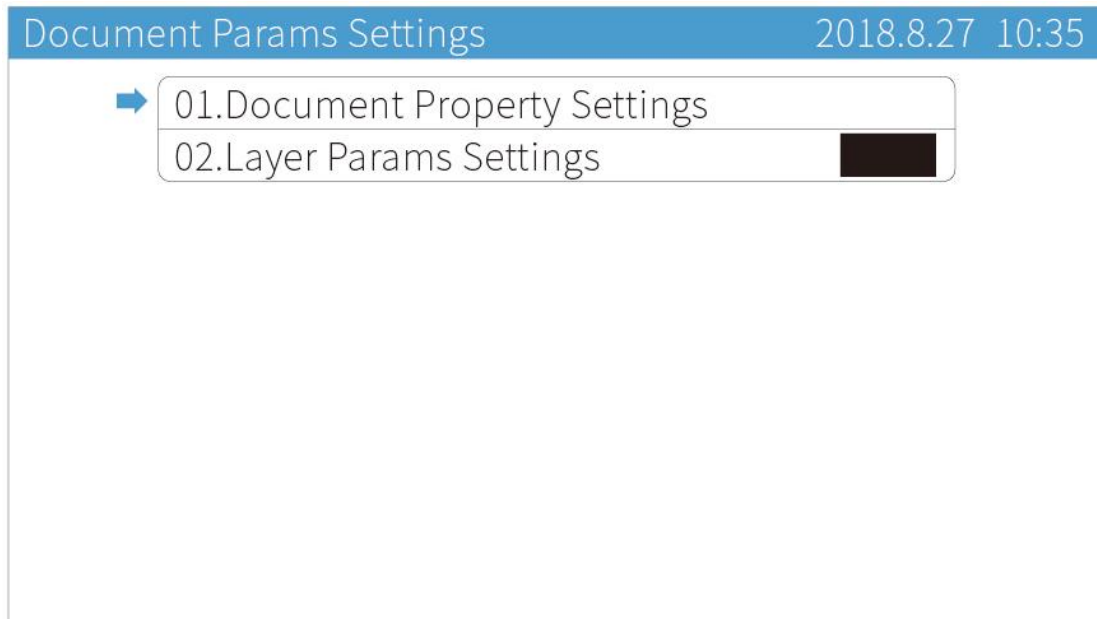

Figure5-1-2 Document Params Settings



Move the cursor to **【Document Property Settings】** , press **【Enter】** . Press **【↑】【↓】【←】【→】** to move cursor, press **【Z↑】【Z↓】** to modify parameters, and press **【Enter】** to save settings.

Figure5-1-3 Set Document Property

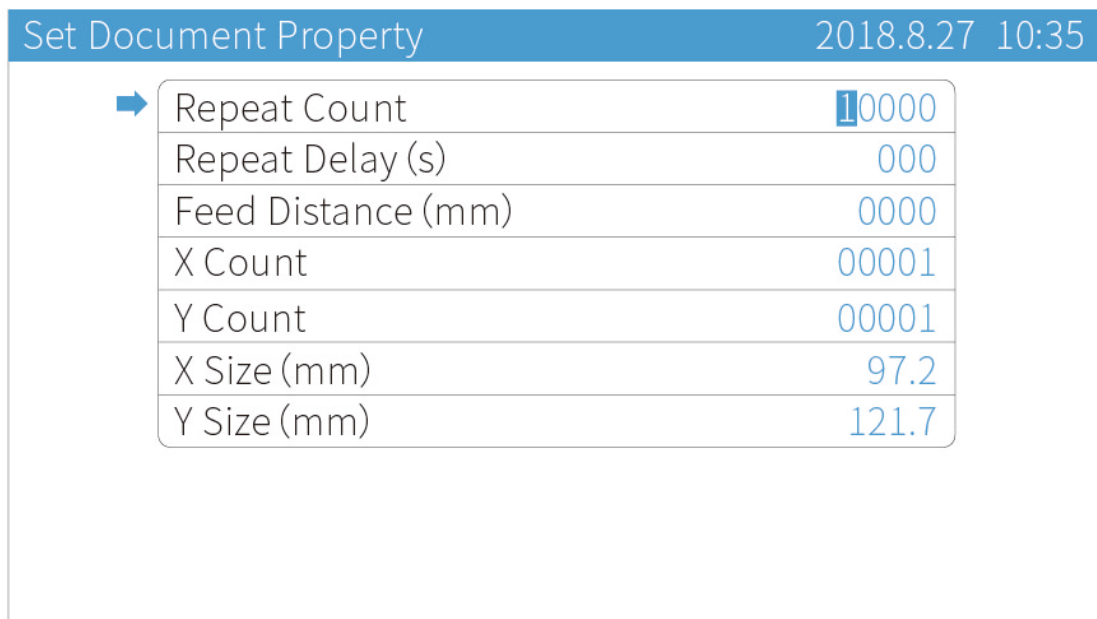

Table5-1-1 Set Document Property Instruction

Name	Instruction
Repeat Count	Machine repeat working times.
Repeat Delay (s)	The interval between the initial file being finished and the next one of the same.
Feed Distance (mm)	Distance of each movement of the feeding axis.
X Count	The number of graphics s processed by machine in the X direction.
Y Count	The number of graphics s processed by machine in the Y direction.
X Size (mm)	The size of graphics in X direction.
Y Size (mm)	The size of graphics in Y direction.

5.1.2 Layer Params Settings

On the **Document Params Settings** page, move cursor to **【Layer Params Settings】** and press **【Enter】**. On the **Layer Params Settings** page, press **【↑】【↓】【←】【→】** to move cursor, press **【Z↑】【Z↓】** to modify parameters, press **【Enter】** to save settings.

During cutting the current layer, if the cutting lines are uneven (different cutting depth), the maximum and minimum power of the laser head shall be adjusted to ensure the best cutting effect. If the maximum and minimum power is set too high, the cutting material may be damaged. If set too low, may cause incomplete cutting. Users could set appropriate maximum and minimum power values according to different cutting materials.

Figure5-1-4 Layer Params Setting

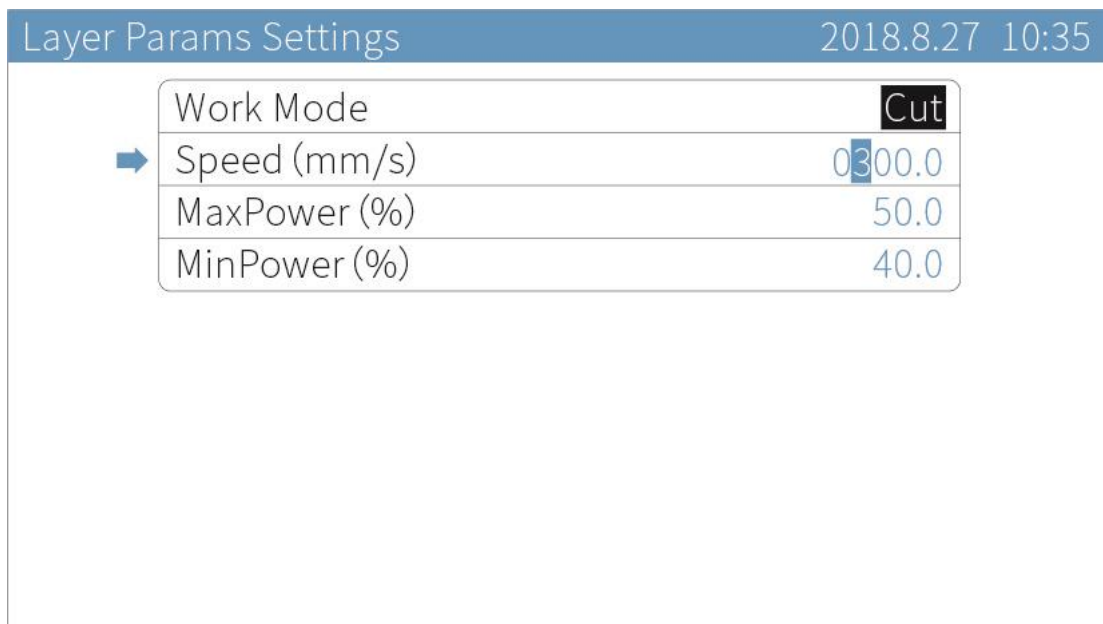

Table5-1-2 Layer Params Setting Instruction

Name	Instruction
Work Mode	The mode of processing graphics.
Speed (mm/s)	The speed of processing graphics.

Max Power (%)	The max power of laser head (working power).
Min Power (%)	The min power of laser head (turning power).

5.2 Count

On the main page, press **【Enter】** , then move cursor to **【Count】** . Press **【Enter】** . Move cursor to **【To Clear Current count】** and press **【Enter】** to clear the current counts.

Figure5-2-1 Clear Total Count

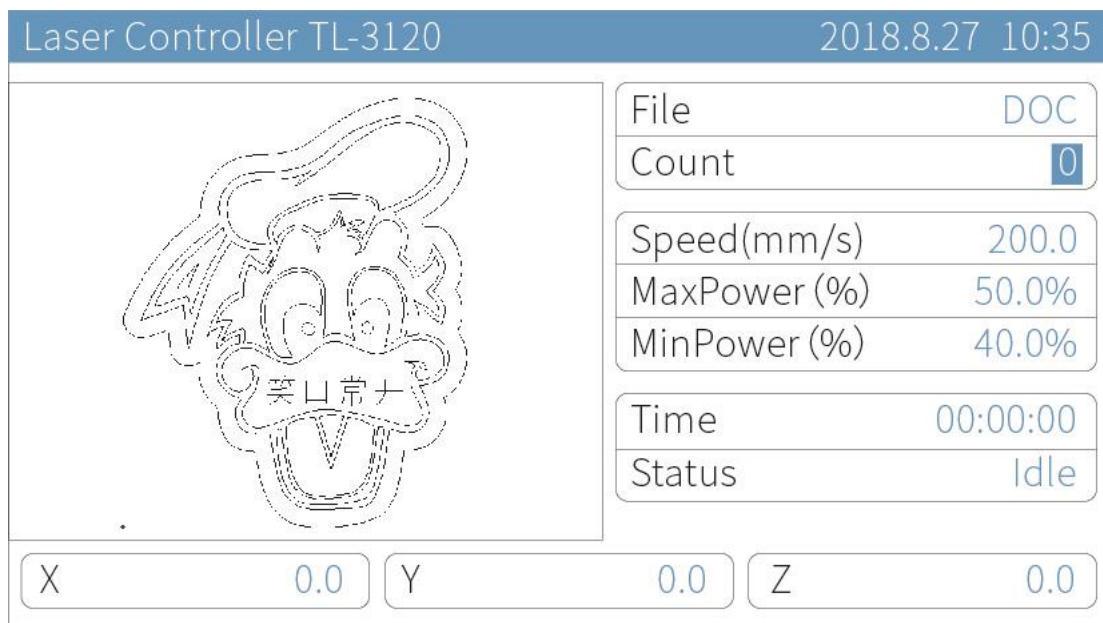
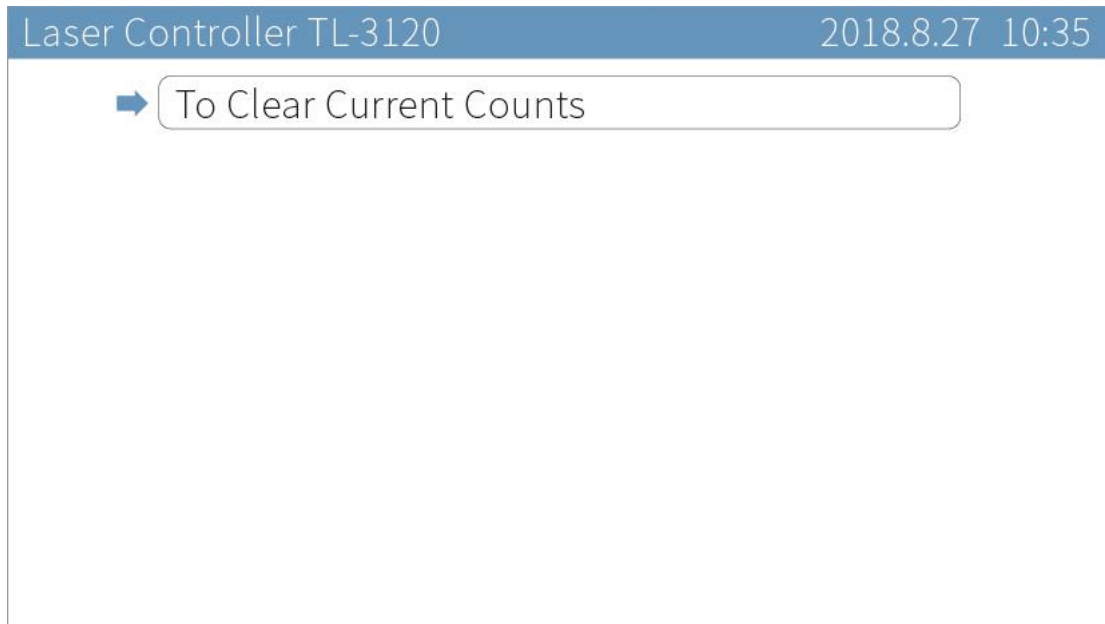

Figure5-2-2 Clear Total Count



5.3 Working Property

On the main page, press **【Enter】** to make the cursor highlighted and move cursor to **【Speed】** . Press **【Enter】** to open ***Set Laser Power While Idle*** page.

Figure5-3-1 Select Speed Option

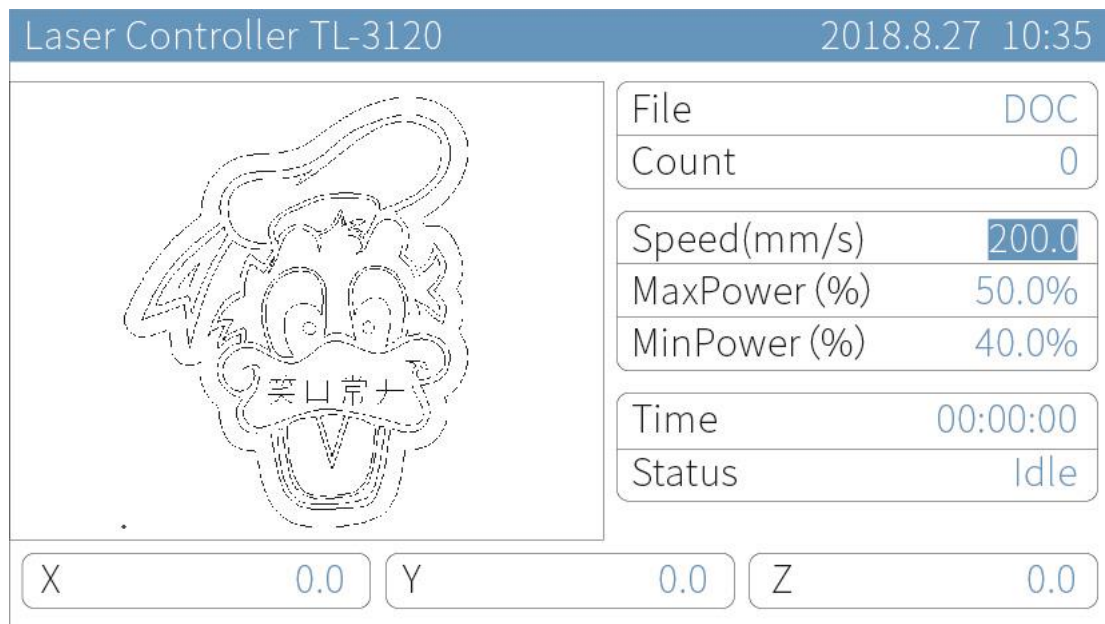

Press **【 ↑ 】【 ↓ 】【 ← 】【 → 】【 Z ↑ 】【 Z ↓ 】【 Enter 】【** to move cursor, press **【 Z ↑ 】【 Z ↓ 】【** to modify parameters, and press **【 Enter 】【** to save settings.

Figure 5-3-2 Idle Laser Power Setting Page

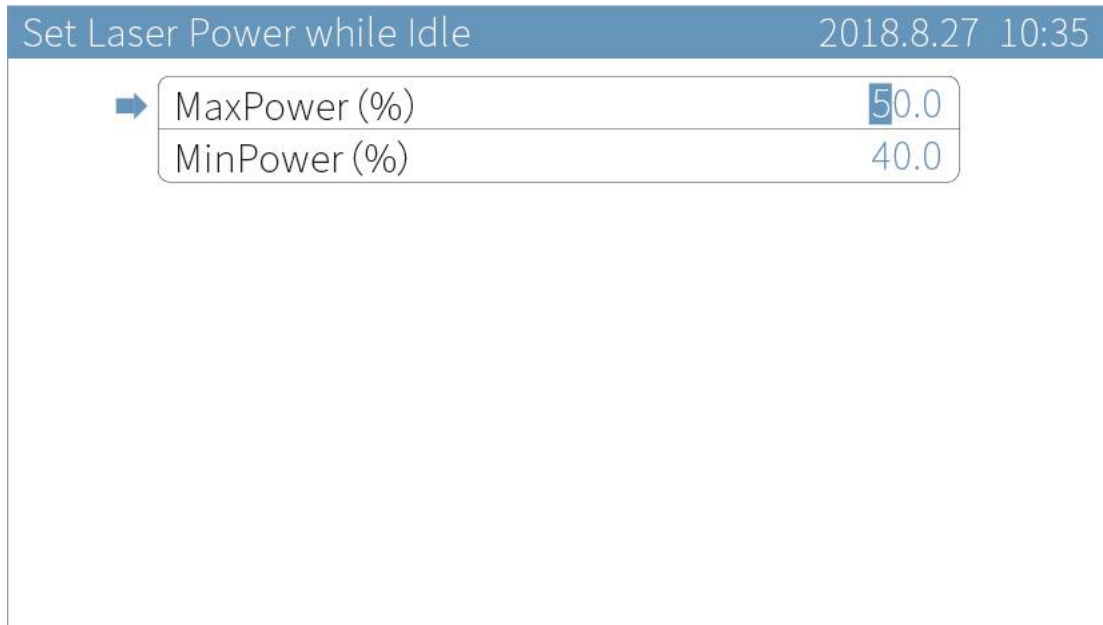

Table 5-3-1 Idle Laser Power Instruction

Name	Instruction
Max Power (%)	Laser power of Laser.

6. System Menu

6.1 U Disk Files

Insert a U disk into the U disk slot on the panel. If your U disk has a "light indicator" (shows connectivity) and shows that it's connected, press

【Menu】 to enter the main menu, move the cursor to **【U Disk Files】** then press **【Enter】** to enter U disk files management.

Figure6-1-1 Main Menu Interface

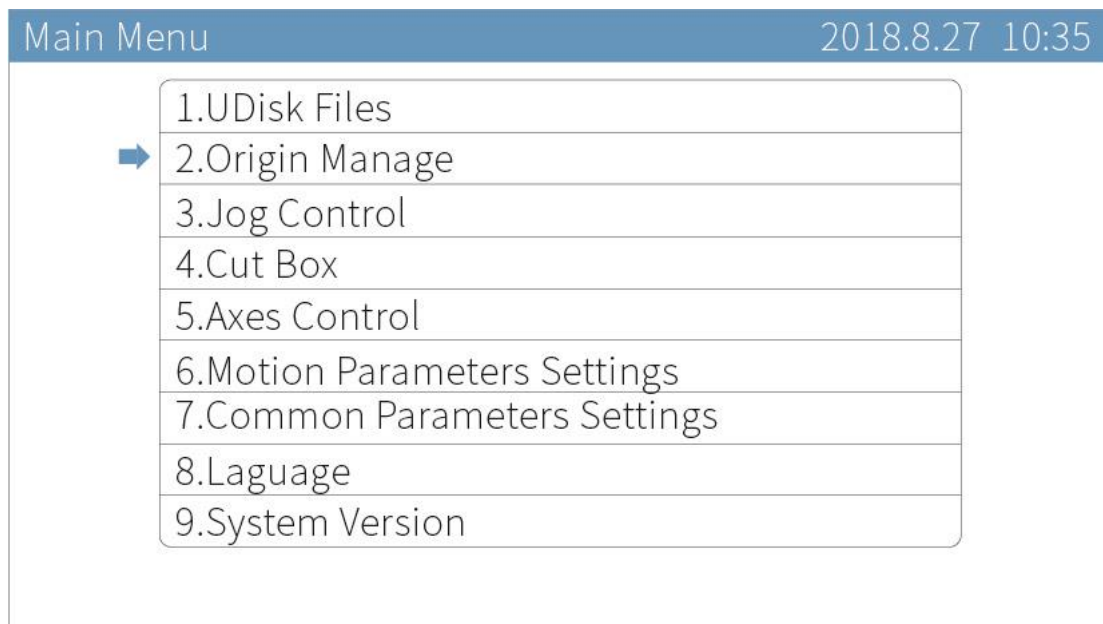
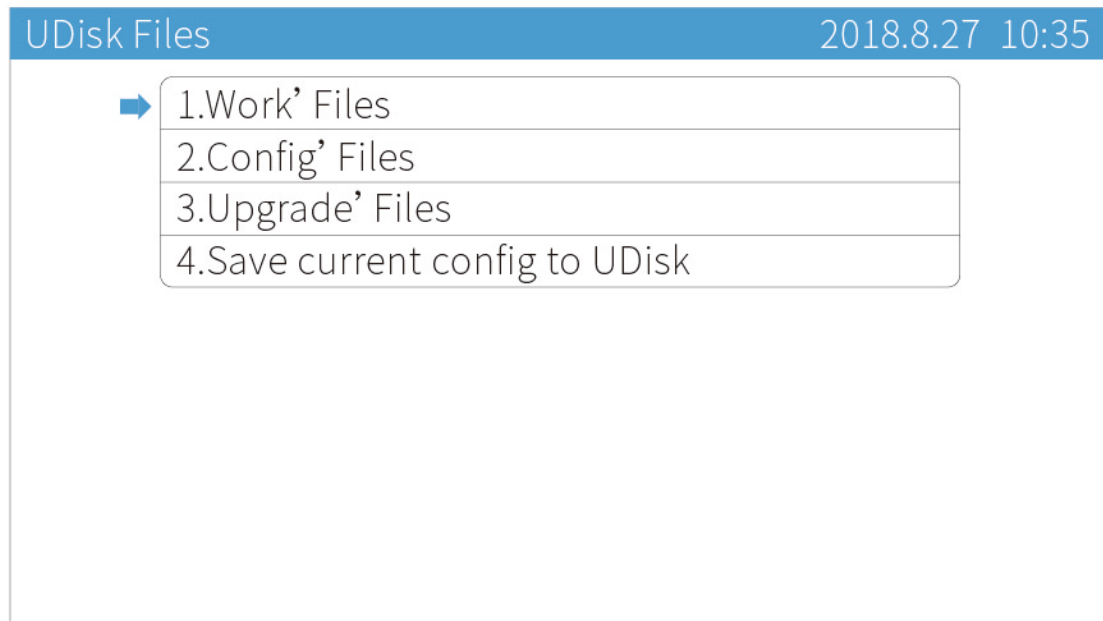

Figure6-1-2 U Disk Files



- ① The U disk must be formatted to FAT32 File system in advance. Quick Format is forbidden. Any other files formations are not supported.
- ② Recommend using a U disk with a "light indicator" to ensure if the U disk is connected successfully with the main board
- ③ When the U disk has never been able to read, try using a different U disk.
- ④ The U disk can't be used to install system.

If the U disk can't be read, you will see the interface below.

Figure6-1-3 No U Disk Interface

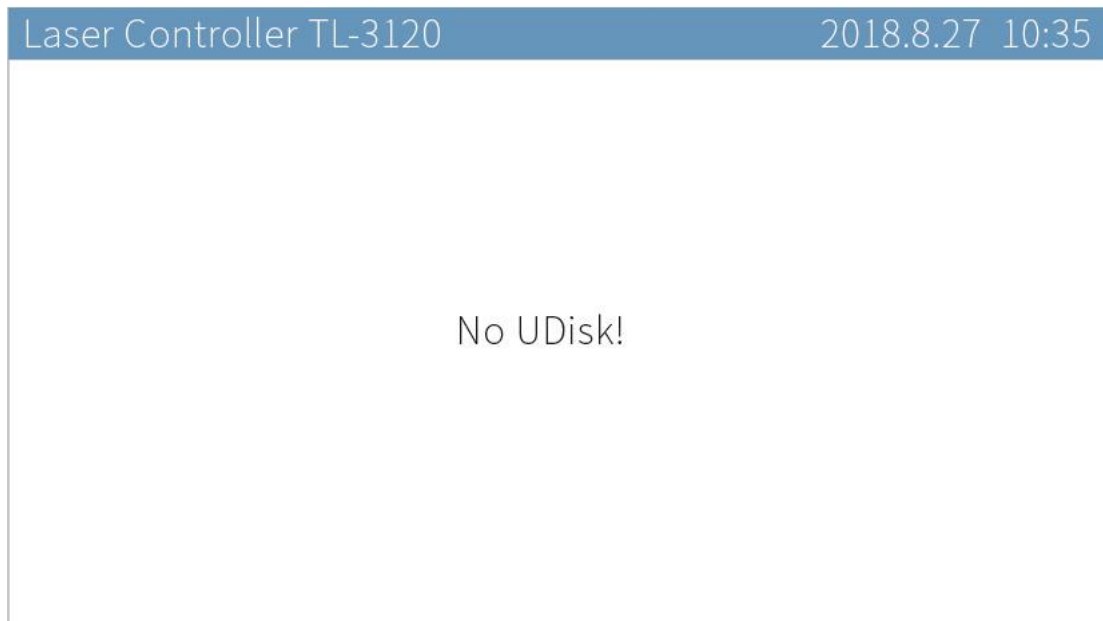

6.1.1 Work Files

Move the cursor to **【Work Files】** and press **【Enter】** . On the panel, the working file in the U disk will be presented. The right side shows the working file previewing. Press **【↑】** **【↓】** to move cursor and press **【Enter】** to copy the working file from U disk to mainboard storage.

Figure6-1-4 U Disk Work Files List

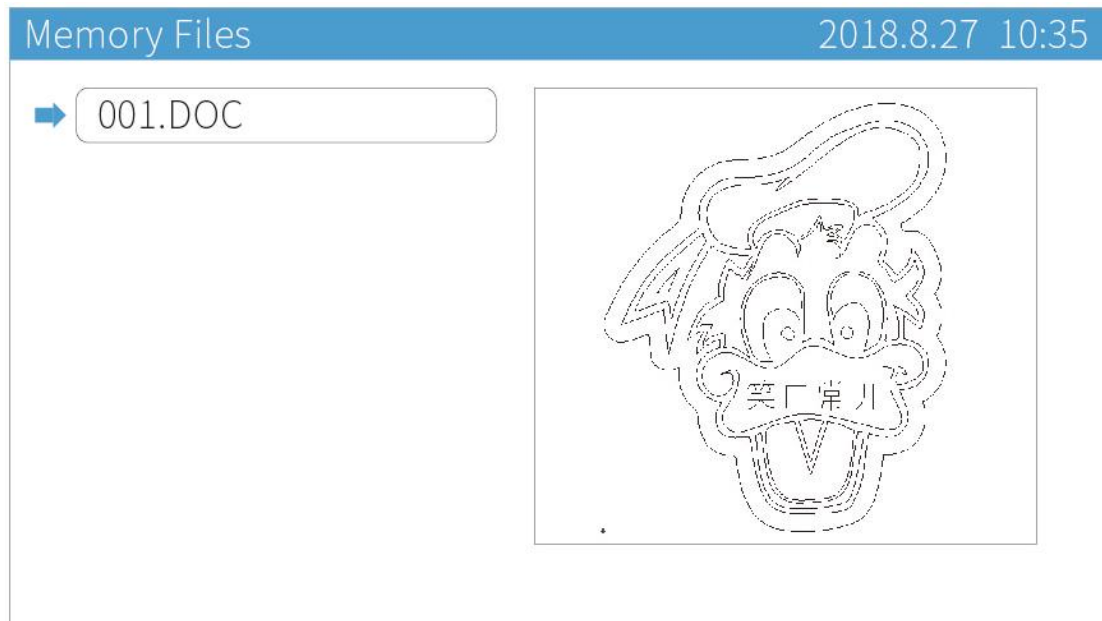

The working file in the U disk is saved with a suffix of UD5. Files other than the “.UD5” file extension will not readable.

6.1.2 Config Files

Move cursor to **【Config File】** and press **【Enter】** . Move cursor to the file which you need to copy to main board. Then Press **【Enter】** to save current config file to mainboard.

Figure6-1-5 Config Files List

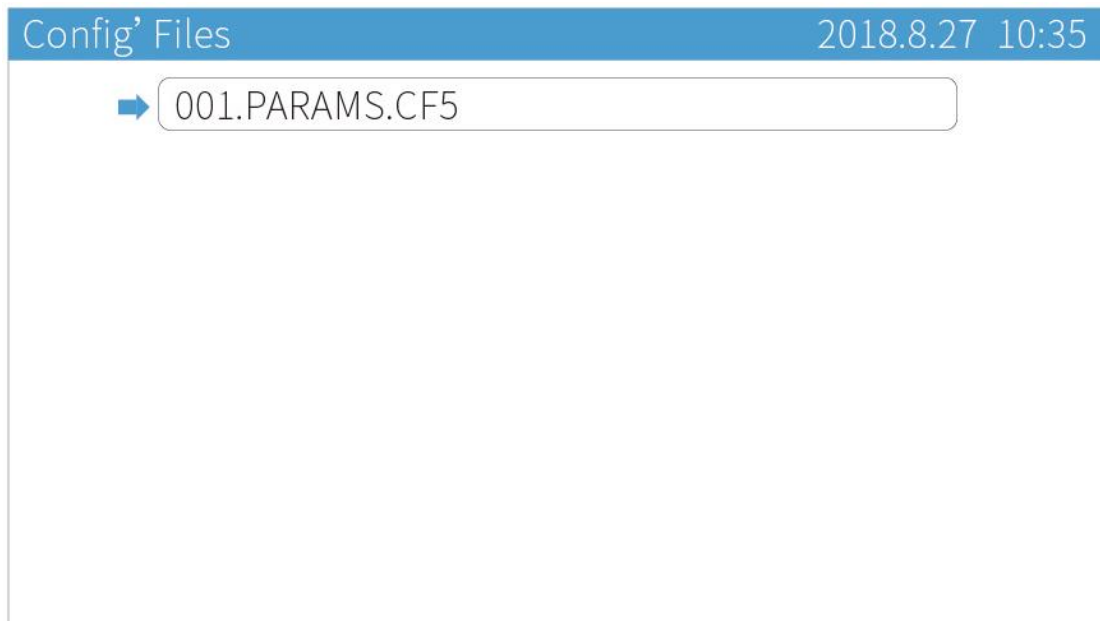

6.1.3 Upgrade Files

Move cursor to **【Upgrade Files】** and press **【Enter】** . Move the cursor to the file you need, press **【Enter】** then it will start the upgrading process.

Figure6-1-6 Upgrade Files

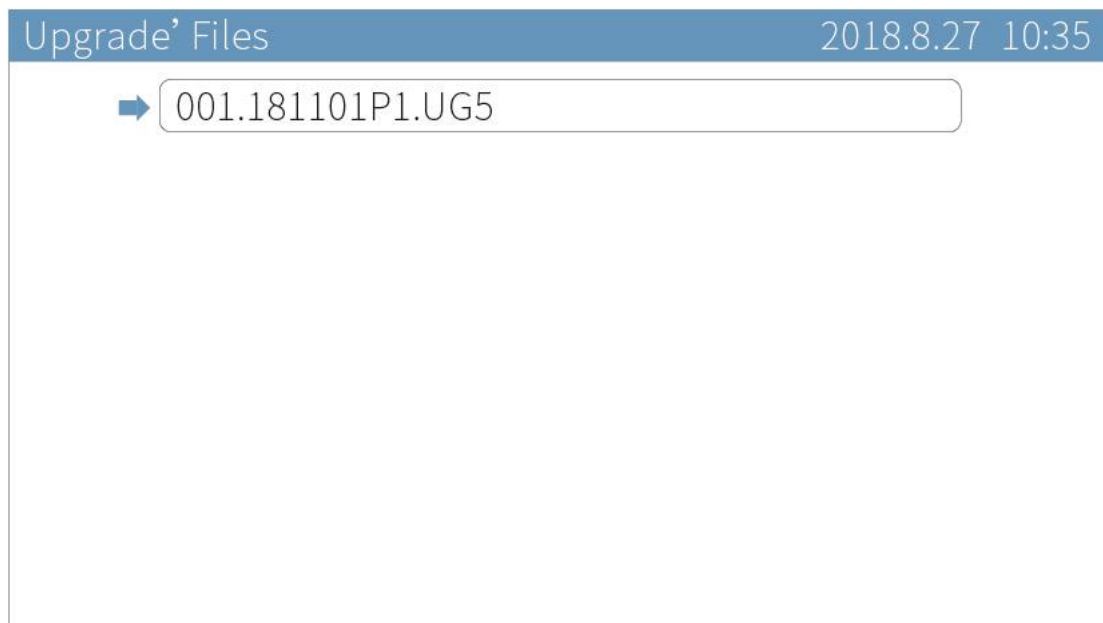



Don't turn off the power during upgrade, otherwise it will cause damage to the mainboard. The upgrade will take about 30s. After finishing upgrade, the mainboard will reset automatically.

6.1.4 Save Current Config to U Disk

Move cursor to **【Save Current Config to U Disk】** and press **【Enter】** to save current mainboard config file to the U disk. And the file will be named as “Params.CF5” in the U disk.

Figure6-1-7 Save Current Config to U Disk

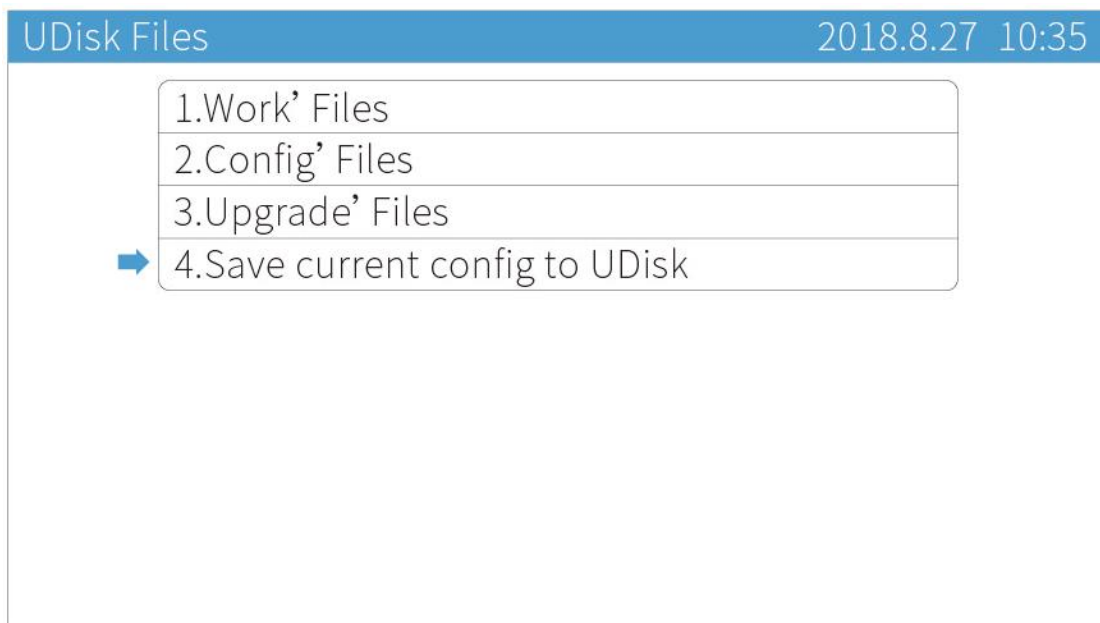

6.2 Origin Manage

On the main page, press **【Menu】**, and move cursor to **【Origin Manage】**, press **【Enter】** . You will see ***Origin Manage*** page.

Figure6-2-1 Origin Manage Interface

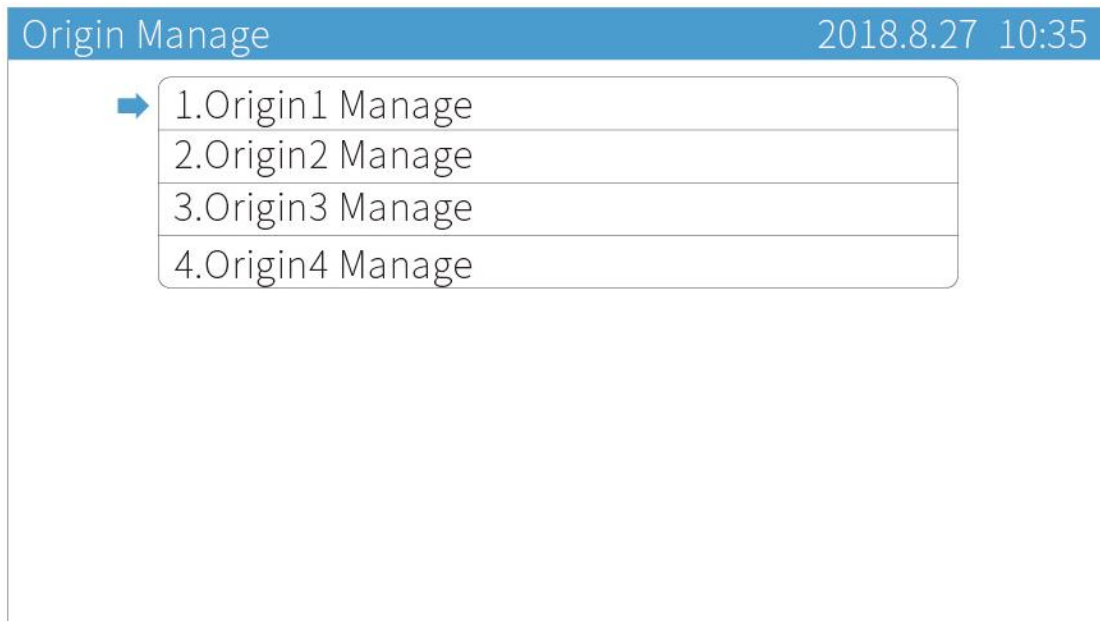

Move cursor to **【Origin1 Manage】** , press **【Enter】** to enter the ***Origin1 Manage*** interface. Move cursor to **【Set current position as the origin】** , press **【Enter】** to set the current position of laser head as origin point. Other origin points will be set like this.

【The origin PX】 and **【The origin PY】** show the coordinates of current origin point. Users can accurately determine the origin point according to the coordinate value. The system supports up to 4 origin points. Users can select any origin points for use by pressing **【Move head to the origin】** key. This function is used for rapid switching of different points of laser head.

Take **【Origin1 Manage】** as an example.

Figure6-2-2 Origin Mange Instruction

Origin1 Manage		2018.8.27 10:35
➔	1.Move head to the origin	
	2.Set Current Position as the origin	
	3.The origin' PX (mm)	0000.0
	4.The origin' PY (mm)	0000.0

6.3 Jog Control

On the main page, press **【Menu】**, move cursor to **【Jog Control】** and press **【Enter】** to enter **Jog Control** page. Then press **【Z ↑】【Z ↓】** to modify the distance. Do not set too large **【Jog Distance】**, please make sure it within the working range.

On the **Jog Control** page, press **【Z ↑】【Z ↓】** to modify the jog distance when the cursor is displayed in inverse color. Press **【Z ↑】【Z ↓】** to move cursor, press **【↑】【↓】【←】【→】** to make motion axis jog when the cursor is not displayed in inverse color.

The jog control can move axis accurately and adjust the distance per pulse of axis. [Please check the Chapter 3.5 to know more about distance per](#)

[pulse.](#)

Figure 6-3-1 Jog Control Interface

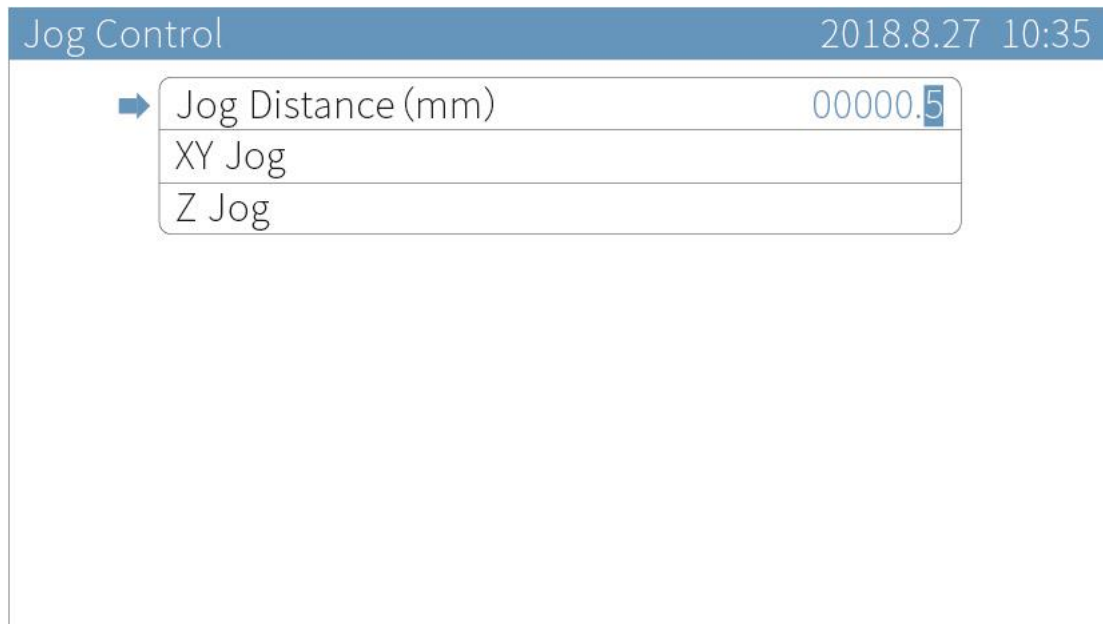

6.4 Cut Box

On the main page, press **【Menu】** and move cursor to **【Cut Box】**, press **【Enter】** to enter the **Cut Box** page. Move cursor to **【Blank Distance】**, and press **【Z ↑】** **【Z ↓】** to modify parameters, then move cursor to **【Start cutting box】** and press **【Enter】** to start cut box function.

When cutting box, the laser head keeps a certain distance (Blank Distance) from the outside edge of the graphics from the registration point, and cuts a square, which is used to determine the location of the origin point of the laser head and the actual size of graphics.

Figure 6-4-1 Cut Box Interface

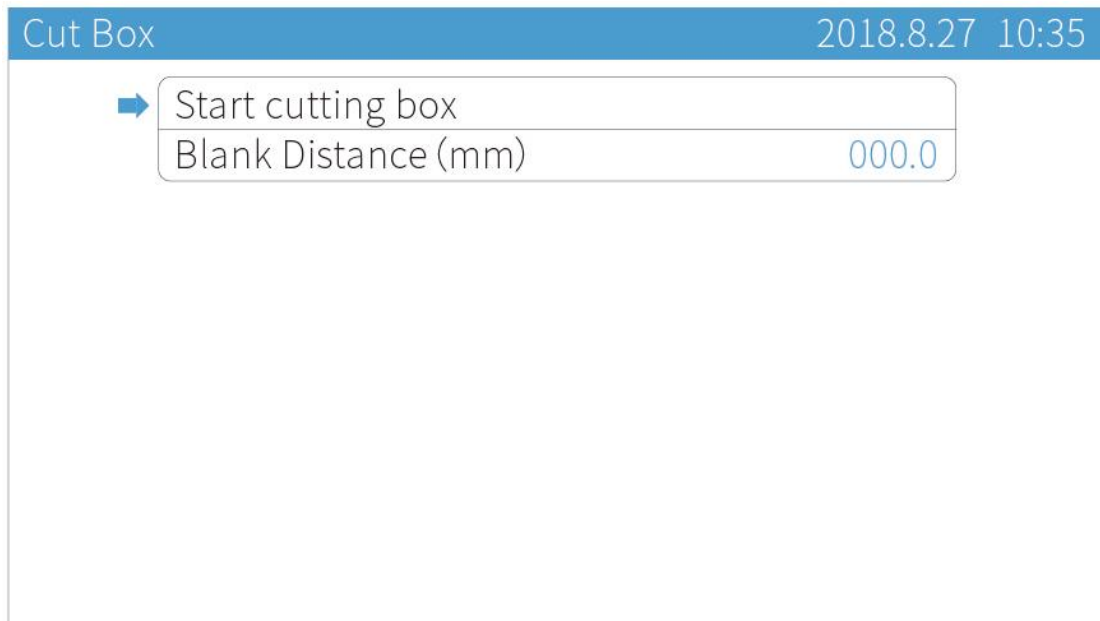

Table 6-4-1 Cut Box Instruction

Name	Instruction
Blank Distance (mm)	The distance between the border of graphics s and the border of cutting.

6.5 Axes Control

On the main page, press **【Menu】** and move cursor to **【Axes Control】** , press **【Enter】** to enter ***Axes Control*** page. Press **【↑】****【↓】** to move cursor, and press **【Enter】** to make axis reset.

The Z axis can be used as the lifting shaft and platform lifting shaft. When the Z axis is reset, the Z axis will stop at the limiter position.

The【Z AutoFocus】function is mainly used to control the distance between the laser head and the work table. If the Z axis is used as the lifting shaft or platform lifting shaft, users can turn on the 【Z AutoFocus】 function and set 【AutoFocus Distance】 to keep the distance between laser head and working table.

Figure6-5-1 Axes Control Interface

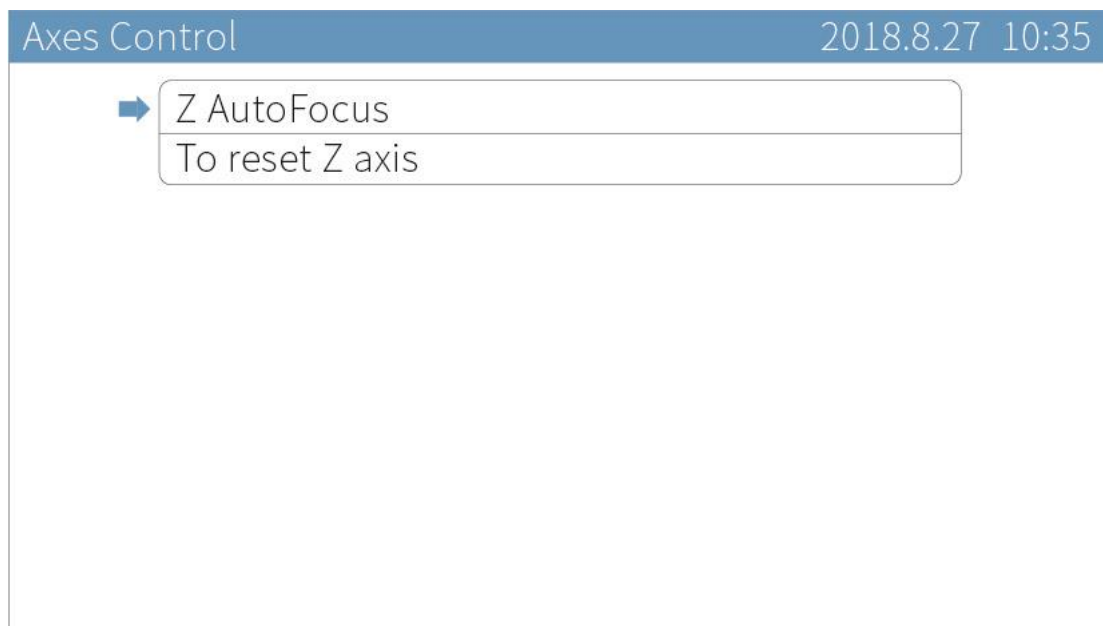

6.6 Motion Parameters Settings

On the main page, press 【Menu】 and move cursor to 【Motion Parameters Settings】, press 【Enter】 to enter *Motion Parameters Settings* page. Press 【↑】【↓】 to move cursor and press 【Z↑】【Z↓】 to modify parameters, press 【Enter】 to save settings.

Figure 6-6-1 Motion Parameters Settings Interface

Motion Parameters Settings		2018.8.27 10:35
➔	Space Speed (mm/s)	0300.0
	Cut Jerk (10000mm/s ³)	0.60
	Space Jerk (10000mm/s ³)	10.0
	Min Acc (mm/s ²)	0300
	Engrave Acc (mm/s ²)	10000
	Start Speed (mm/s)	10.0
	Speed Factor	3.0

The settings of these parameter items will affect the cutting effect, please adjust according to your requirements.

Table 6-6-1 Motion Parameters Instruction

	Name	Instruction
	Space Speed (mm/s)	The movement speed of laser head when there is no laser output.
	Cut Jerk (mm/s ³)	The variation of cutting acc increases or decreases in unit of 10 thousand each time.
	Space Jerk (mm/s ³)	The variation of movement acc when there is no laser output and it increases or decreases in unit of 10 thousand each time.
	Min Acc	The acceleration of laser head when it turns and

	(mm/s ²)	this value increases or decreases in unit of 50 or 100 each time.
	Engrave Acc (mm/s ²)	The variation of engraving speed and it is only effective to engrave.
	Start Speed (mm/s)	The initial speed of laser head from rest to motion.
	Speed Factor	Parameter changes throughout the system. We suggest that lower speed is going to be filled in with 0.5 or 1, while regular speed with 2 and high speed with 3 or 4. This option should be filled in with 0.05 when cutting acrylic or wood. It also has an impact on smoothness when turning.

During cutting process, if the actual cutting speed is far less than the working speed users have set, it indicates that the **【Cut Jerk】** is set too small, so that the laser head cannot reach the set working speed quickly. If the actual cutting speed is relatively fast, the cutting line will jitter, this case indicates that the **【Cut Jerk】** is set too high and the parameter value should be reduced. In the same way, if the **【Space Jerk】** is set too small, the speed of laser head will not reach the set speed when there is no laser output. If the parameter is set too large, the initial position of cutting (after the laser head moving without laser) will jitter.

The start speed is the initial speed of the laser head from rest to start movement. If the cutting line is too thick at the initial position of cutting, it indicates that the parameter value is too small. If the line jitters at the initial position of cutting, this parameter value is set too large.

The speed factor controls the speed of turning during cutting. If the cutting line is too thick when turning, the parameter is too small. If the cutting line is too thin when turning and the graphics cannot be cut completely, this case indicates that this parameter value is set too large, users should set a smaller value.

The **【Engrave ACC】** is the change rate of speed during engraving. This parameter is only valid during engraving. During the engraving process, if the space distance of laser head is too large, then the **【Engrave ACC】** is set too small and should be adjusted appropriately. If the space distance of laser head is too small and the edge of graphics is not carved completely, it indicates that the **【Engrave ACC】** is set too large and should be reduced appropriately.

6.7 Common Parameters Settings

On the main page, press **【 Menu 】** and move cursor to **【 Common Parameters Settings 】** , press **【 Enter 】** .

Figure 6-7 Common Parameters Settings Interface

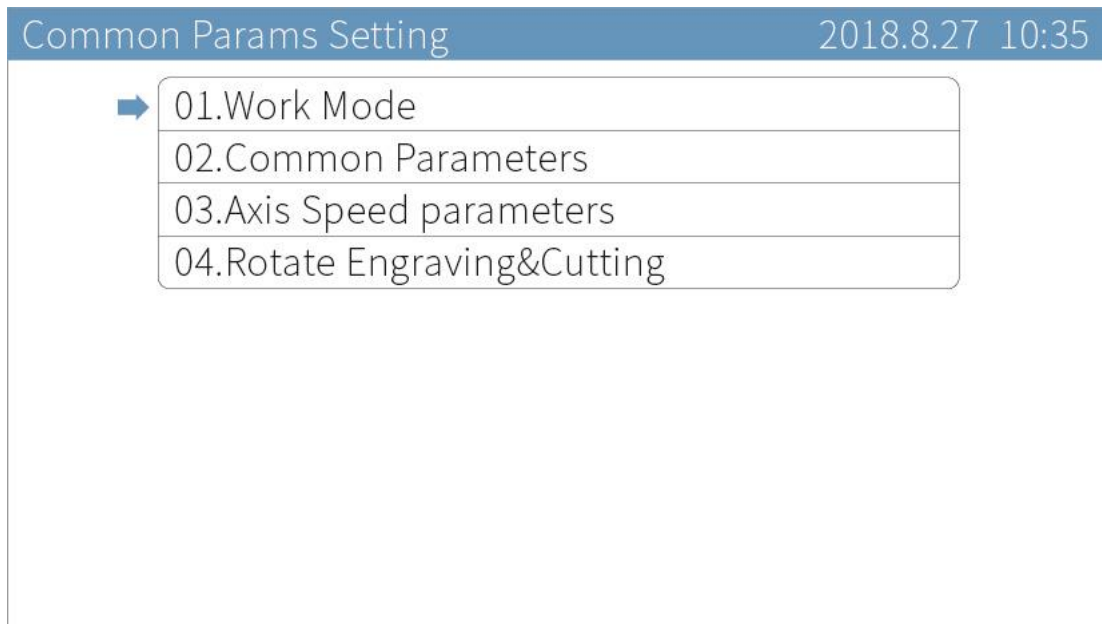

6.7.1 Work Mode

On the ***Common Params Settings*** page, move cursor to **【 Work Mode 】** and press **【 Enter 】** . Press **【 ↑ 】** **【 ↓ 】** to move cursor, press **【 ← 】** **【 → 】** to modify options and press **【 Enter 】** to save settings.

Figure 6-7-1 Common Parameters Settings Interface

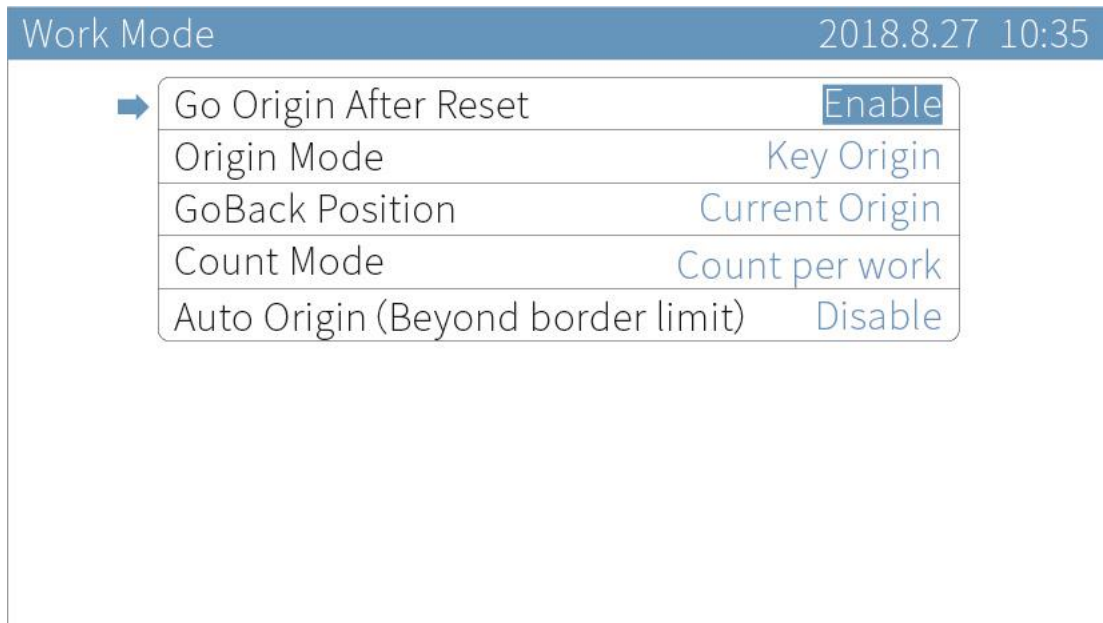

Table 6-7-1 Work Mode Instruction

Name	Instruction
Go Origin After Reset	<p>Enable: the laser head will be back to Origin after resetting.</p> <p>Disable: the laser head will stay at the machine origin point (zero point) after reset.</p>
Origin Mode	<p>Current Position: keep the current position of laser head and set this position as origin point to start cutting.</p> <p>Key Origin: press panel 【Origin】 button after the laser head moved to the chosen position.</p> <p>Soft Origin: set the origin point when drawing a file on LaserCAD software.</p> <p>Machine Zero As Origin: set the machine zero point as origin</p>

	point.
Go Back Position	<p>Current Position: laser head will stay at where task finished.</p> <p>Current Origin: go back to Origin point after finishing work.</p> <p>Zero Coord: laser head goes back to machine zero point since all finished.</p>
Count Mode	<p>Count per work: it will be counted as once after all files cut.</p> <p>Count per Light: it will be counted as once after laser optical output one time.</p> <p>Single of Array: it will be counted as once after the solid graphics in the file is cut.</p>
Auto Origin (Beyond border limit)	Enable or disable the function.

Users can enable or disable the Auto Origin (Beyond border limit) function as required. Disable the function, if the graphics beyond the working range, the system prompts "Beyond border limit! Continue?", press **【Enter】** key to continue to cut, part of the graphics beyond border limit will not be cut, as shown in Figure 6-7-3. Press **【ESC】** to cancel operation.

Figure 6-7-2 Beyond Border Limit

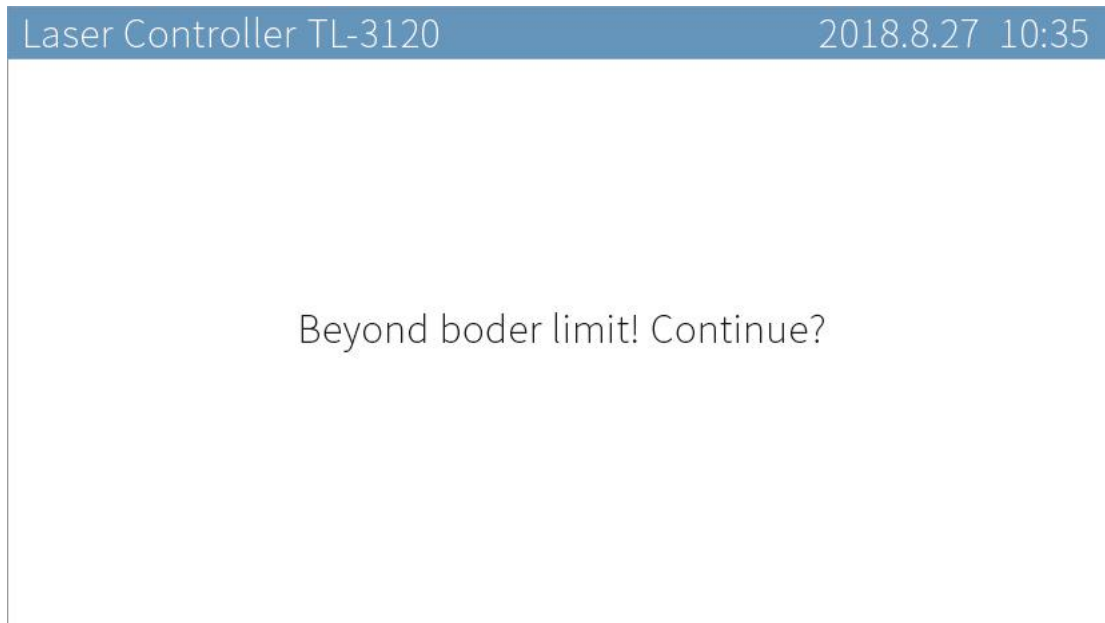

Figure 6-7-3 Part of the Cutting (Panel)

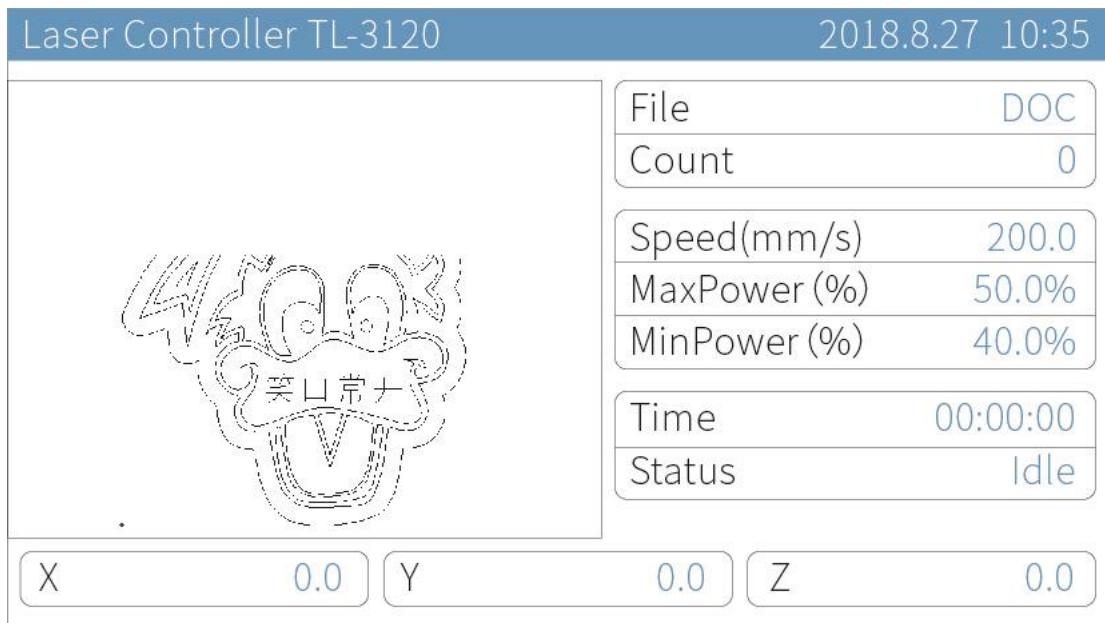
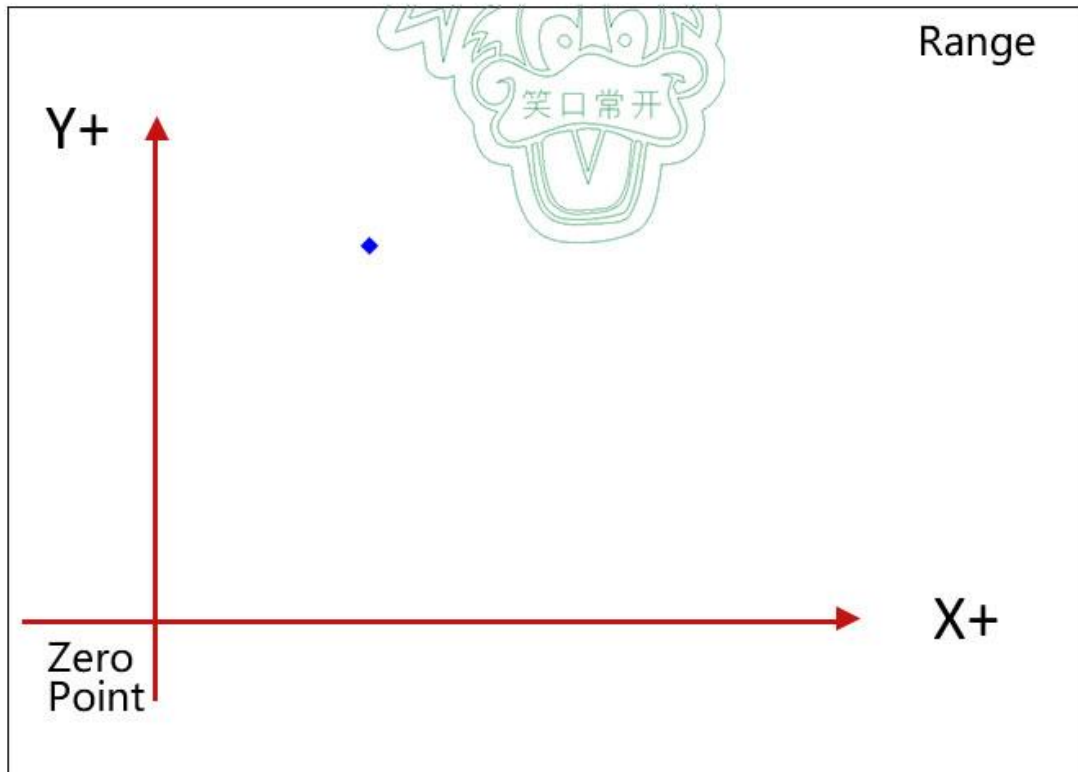

Figure 6-7-4 Part of the Cutting (LaserCAD)



Enable the function, if the graphics beyond the working range, the laser head will automatically adjust position to cut the graphics perfectly. After adjustment, if the graphics still beyond the border, the system prompts "Beyond border limit! Continue?", press **【Enter】** key to continue to cut, part of the graphics beyond border limit will not be cut, as shown in Figure 6-7-3/6-7-4. Press **【ESC】** to cancel operation.

As shown in Figure 6-7-5, the green graphics is beyond the current working range. If enable the function **【Auto Origin (Beyond border limit)】**, the machine will automatically move to the position of the red graphics for cutting. If the graphics is still beyond the border after re-positioning or

disable the function, the machine will only cut part of the graphics which is within the working range like Figure 6-7-4.

Figure 6-7-5 Auto Origin

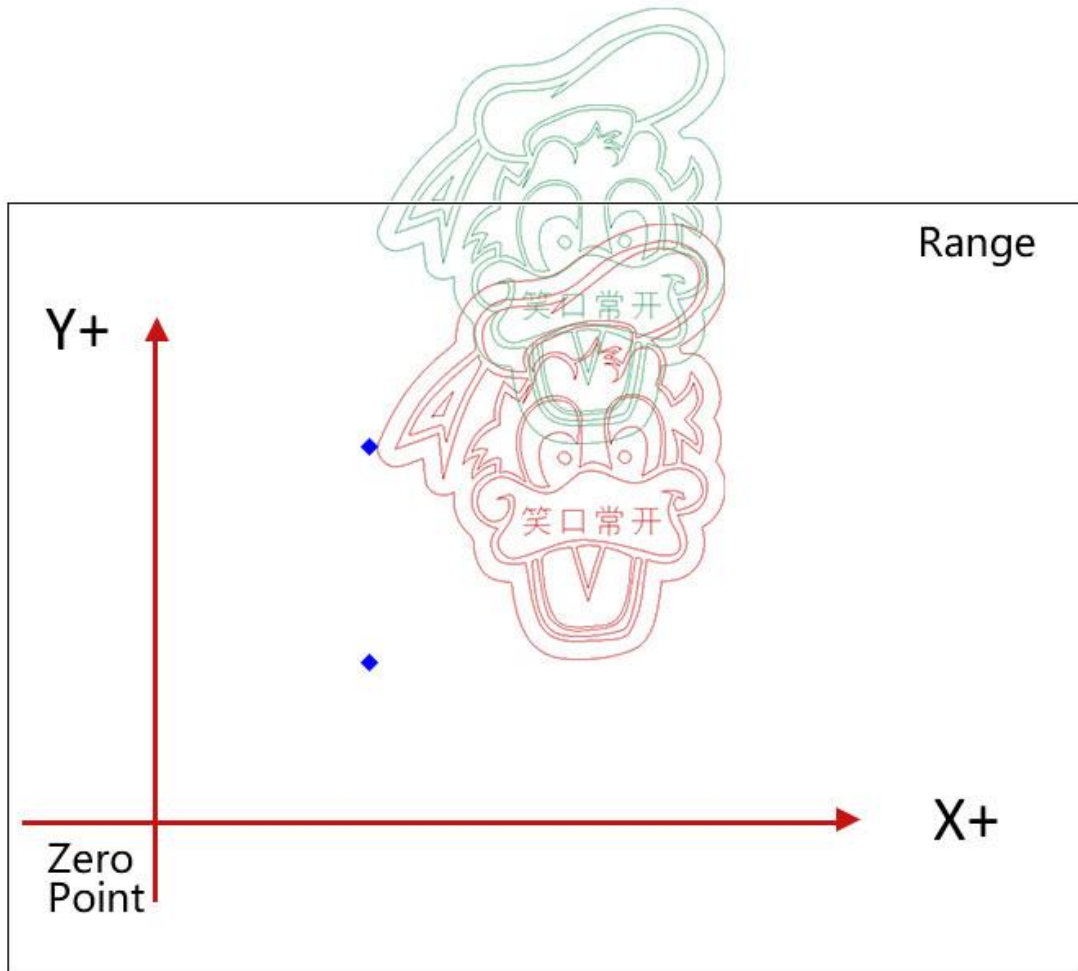

6.7.2 Common Parameters

On the **Common Params Settings** page, move cursor to **Common Parameters** and press **Enter**. Press **↑** **↓** to move cursor and press **Z ↑** **Z ↓** to modify parameters, press **Enter** to save settings. The **Z AutoFocus** function is mainly used to control the distance between the laser head and the work table. If the Z axis is used as the lifting shaft

or platform lifting shaft, users can turn on the **【Z AutoFocus】** function on the **Function Config** page (**【Manufacturer Params Settings】** → **【Function Config】**) and set **【AutoFocus Distance】** here to keep the distance between laser head and working table.

Figure6-7-6 Common Parameters Interface

Common Parameters		2018.8.27 10:35
➔ AutoFocus Distance (mm)	00.0	
KeyMove' Speed (mm/s)	200.0	
RunBox' Speed (mm/s)	200.0	
CutBox' Speed (mm/s)	050.0	
Blow Open Delay (s)	0.00	
Blow Close Delay (s)	0.00	

Table6-7-2 Common Parameters Instruction

Name	Instruction
Auto Focus Distance (mm)	The distance between the laser head and working platform.
Key Move Speed (mm/s)	The motion speed of axis when press the direction keys on panel.
Run Box Speed	The speed at which the laser head runs along the outer

(mm/s)	frame of graphics without laser output.
Cut Box Speed (mm/s)	The speed at which the laser head cuts along the outer frame of graphics.
Blow Open Delay(s)	The period between laser head optical output and air blowing started.
Blow Close Delay(s)	The period between laser head optical output stopped and air blowing stopped.

6.7.3 Axis Speed Parameters

On the **Common Params Settings** page, move cursor to **Axis Speed Parameters** and press **Enter**. Press **↑** **↓** to move cursor and press **Z ↑** **Z ↓** to modify parameters, press **Enter** to save settings.

Figure 6-7-7 Axis Speed Parameters Interface

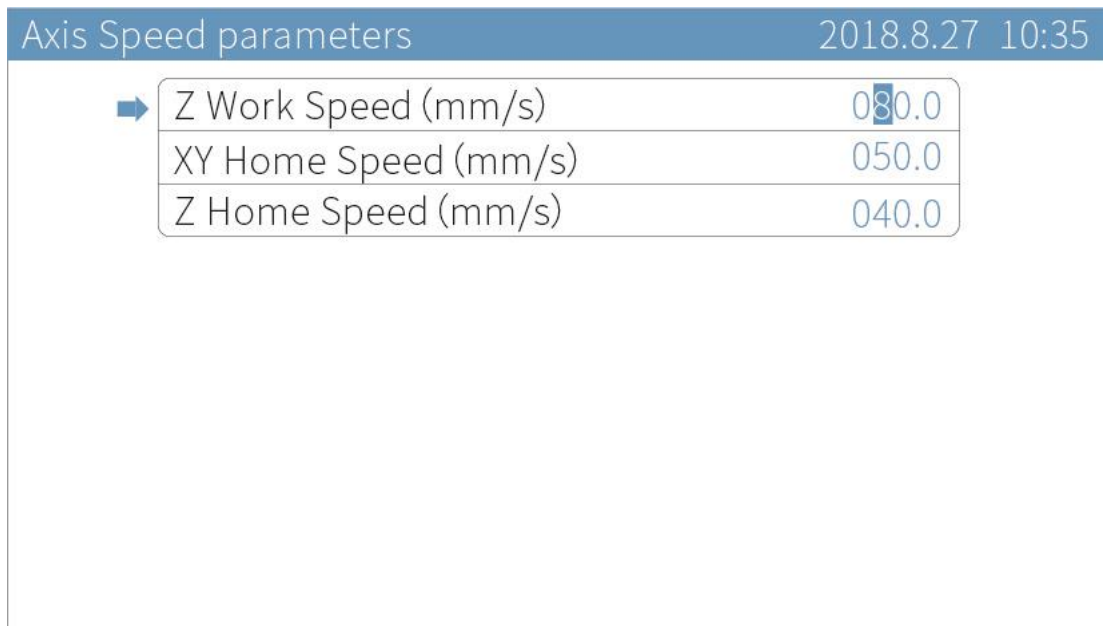

Table 6-7-3 Axis Speed Parameters Instruction

Name	Instruction
Z Work Speed (mm/s)	The work speed of Z axis.
XY Home Speed (mm/s)	The reset speed of XY axis.
Z Home Speed (mm/s)	The reset speed of Z axis.

6.7.4 Rotate Engraving & Cutting

On the **Common Params Settings** page, move cursor to **Rotate Engraving & Cutting** and press **Enter** . Press **↑** **↓** to move cursor, press **←** **→** to modify options and press **Z ↑** **Z ↓** to modify parameters, press **Enter** to save settings.

Figure 6-7-8 Rotate Engraving & Cutting Interface

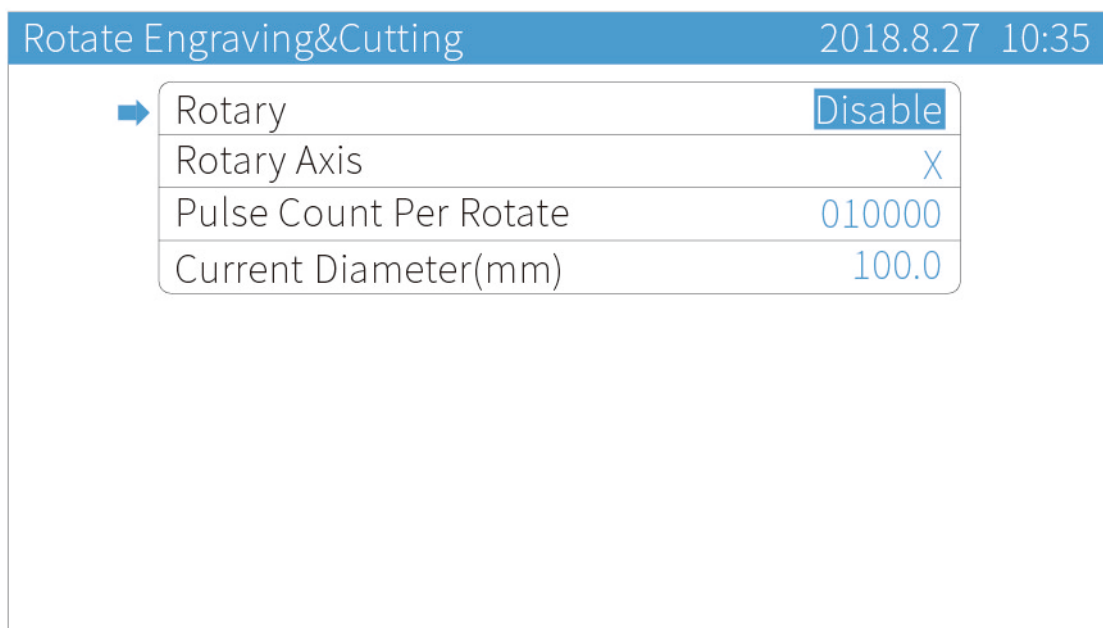

Table 6-7-4 Rotate Engraving & Cutting Instruction

Name	Instruction
Rotary	Enable or Disable rotary engraving function.
Rotary Axis	The axis which rotary engraving uses.
Pulse Count Per Rotate	The pulse parameters for the motor to make the rotary axis rotate one circle.

<p>Current Diameter (mm)</p>	<p>The diameter of the material being processed.</p>
----------------------------------	--

After enable the **【Rotary】** function, reset the machine, the panel prompts “Rotary is Enabled!”. If the current machine does not support the rotate engraving function, the distance per pulse of rotary axis will change, and the machine cannot cut the graphics normally. After turning off the function, reset the machine again, users do not need to set axis parameters (like distance per pulse) the machine can work normally.

Figure 6-7-9 Enable Rotate Engraving & Cutting Function

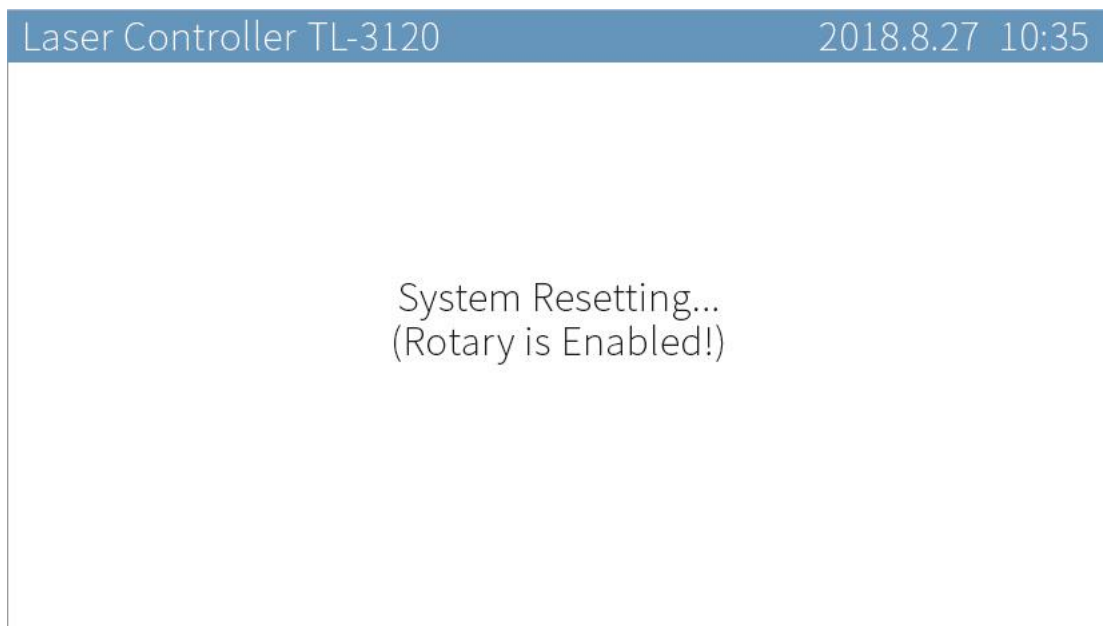

Rotate engraving includes fixture type and roller type, as shown in Figure 6-7-10/6-7-11. The fixture rotate engraving cutting only needs to input the pulse count per rotate and current diameter. The calculation formula of pulse count per rotate is as follows:

Pulse Count per Rotate = Pulse Number of Motor * (Number of Gears in Gear1 / Number of Gears in Gear2)

Figure6-7-10 Fixture Rotate Engraving

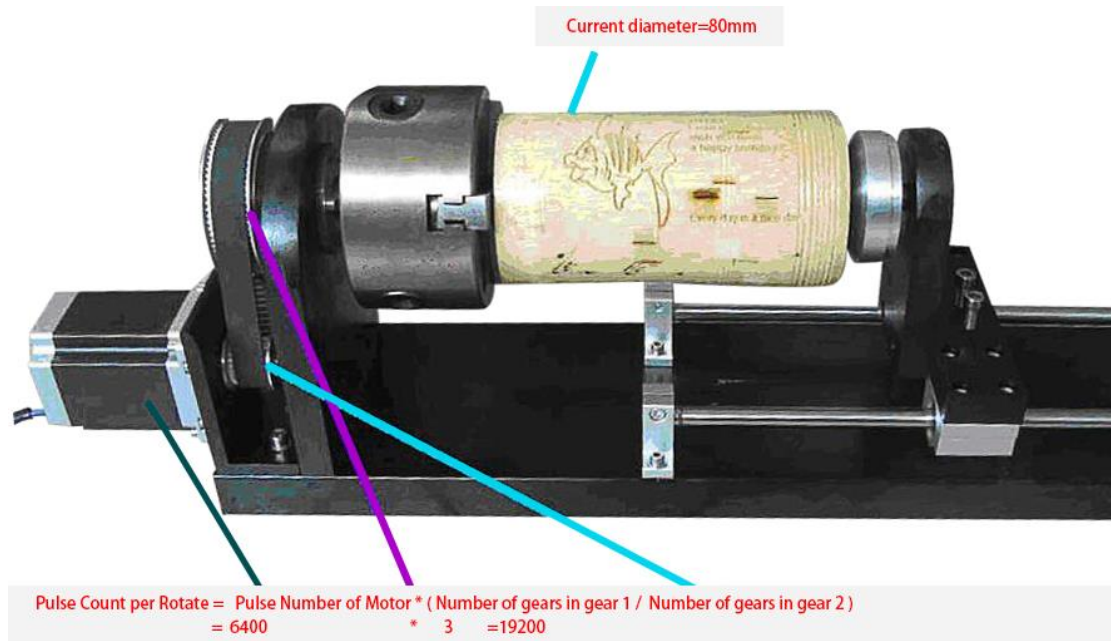

Users should adjust distance per pulse of rotary axis for roller type rotate engraving & cutting (Pulse count per rotate is noneffective). Take X axis as rotary axis as example.

1. Wrap a layer of paper around the roller.
2. In the computer software LaserCAD, draw A straight line section with fixed length as "A" (less than the current cutting object girth).
3. Press **【Start/Pause】** key to cut the line on the paper.
4. Take the same length of the cut trace along the roller with one wool or other convenient object, and measure the length of this wool segment as "B" accurately with a ruler.
5. Enter the ***X Axis Parameters*** interface, move the cursor to **【Distance**

per Pulse】 , press 【Enter】 key to enter the ***To Calculate the Pulse Distance*** interface, fill A into the 【Expected Length】 option, fill B into the 【Actual Length】 option, and click 【Enter】 key to calculate the distance per pulse of X axis (rotary axis).

Figure6-7-11 Roller Rotate Engraving & Cutting



6.8 Language

On the main page, press **【Menu】** and move cursor to **【Language】**, press **【Enter】**. Press **【←】** **【→】** to change language and press **【Enter】** to save settings. TL-3120 now supports 8 kinds of languages, Simplified Chinese, Traditional Chinese, English, Portuguese, Turkish, Russian, French and Korean.

Figure 6-8-1 Language Interface



6.9 System Version

On the main page, press **【Menu】** and move cursor to **【System Version】**, press **【Enter】** to see the system information.

If the encryption or decryption of the mainboard is successful, the product ID will change.

Figure 6-9-1 System Version Interface

System Version		2018.8.27 10:35
Product Name	TL-3120	
Product ID	08021008 00000000	
Version	1.18.10.25	
→ User authorization code		

Move cursor to **【User authorization code】** and press **【Enter】**. Press **【↑】** **【↓】** to move cursor, press **【Z↑】** **【Z↓】** to modify parameters and press **【Enter】** to save settings.

The user authorization code is used for encryption or decryption. If you don't need encryption, there is no need to modify it. If you need encryption, please see the detail in encryption manual.

Figure 6-9-2 User Authorization Code Interface

User authorization code		2018.8.27 10:35
→ Code 1	100000	
Code 2	100000	
Code 3	100000	

7. Manufacture Params Settings

On the main page, press **【 Stop 】** + **【 Shift 】** together, you will see **Manufacture Params Settings** page.

Figure7-1 Manufacture Params Interface

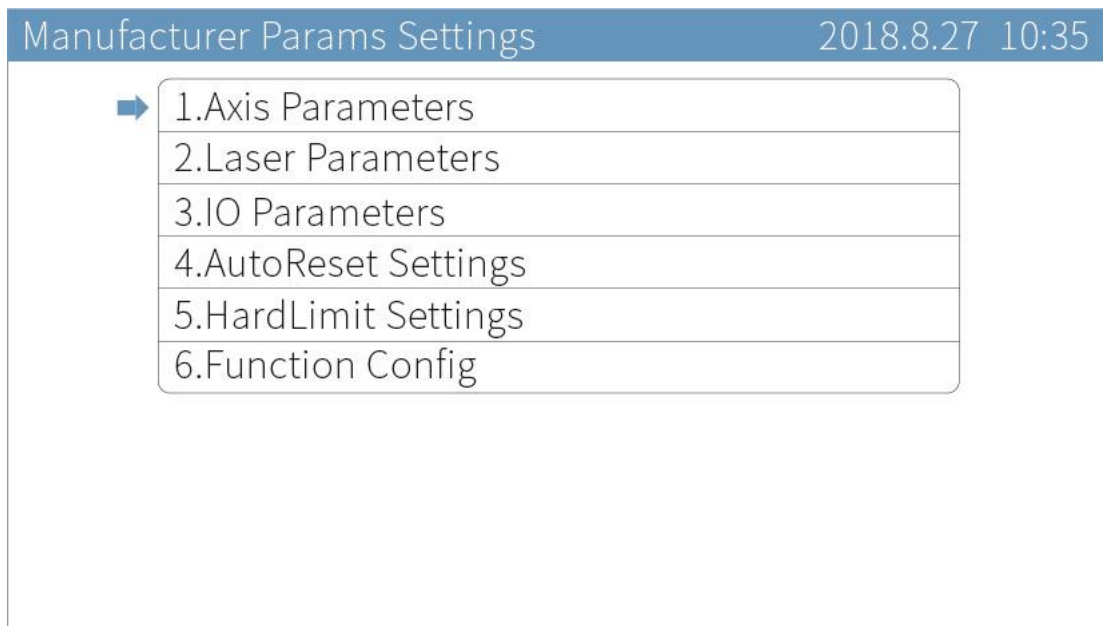

7.1 Axis Parameters

Move cursor to **【 Axis Parameters 】** and press **【 Enter 】** . Take the X axis parameter setting as an example, other axis parameter settings are the same.

Figure7-1-1 Axis Parameters Interface

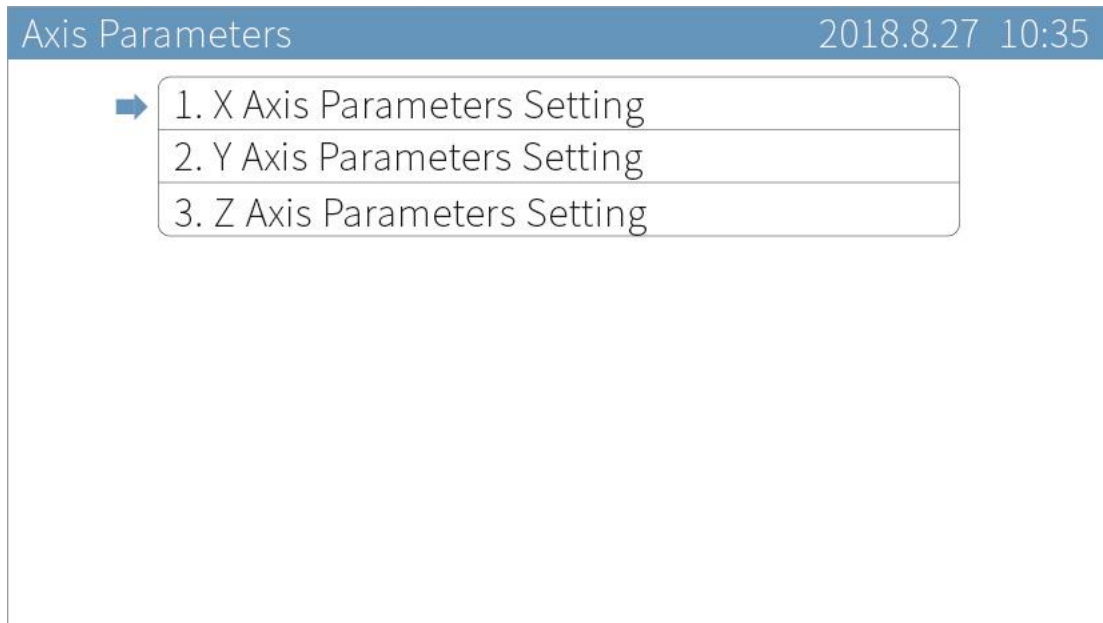

On the **X Axis Parameters** page, press **【 ↑ 】** **【 ↓ 】** to move cursor, press **【 ← 】** **【 → 】** to modify options, press **【 Z ↑ 】** **【 Z ↓ 】** to modify parameters and press **【 Enter 】** to save settings.

Figure7-1-2 X Axis Parameters Interface

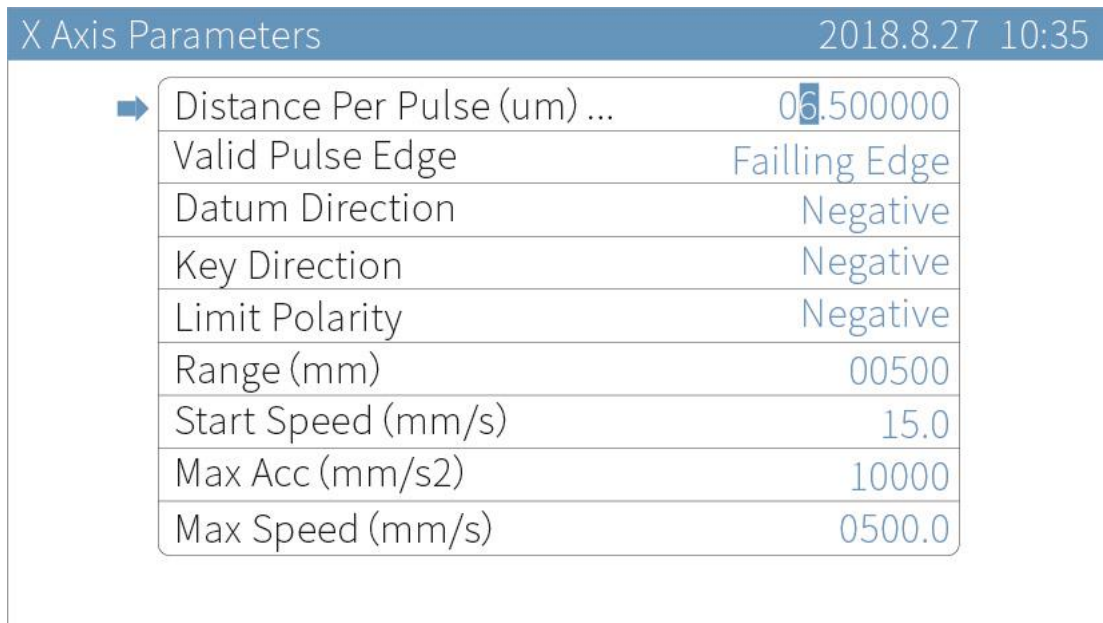

Move cursor to **【 Distance Per Pulse 】** , press **【 Enter 】** to enter the **To**

Calculate the Pulse Distance page. Press **【 ↑ 】****【 ↓ 】** to move cursor, press **【 Z ↑ 】****【 Z ↓ 】** to modify parameters, and press **【 Enter 】** to calculate the distance per pulse. [The calculation of distance per pulse, please refer to the Chapter 3.5 for more details.](#)

Figure7-1-3 Calculate the Distance Per Pulse

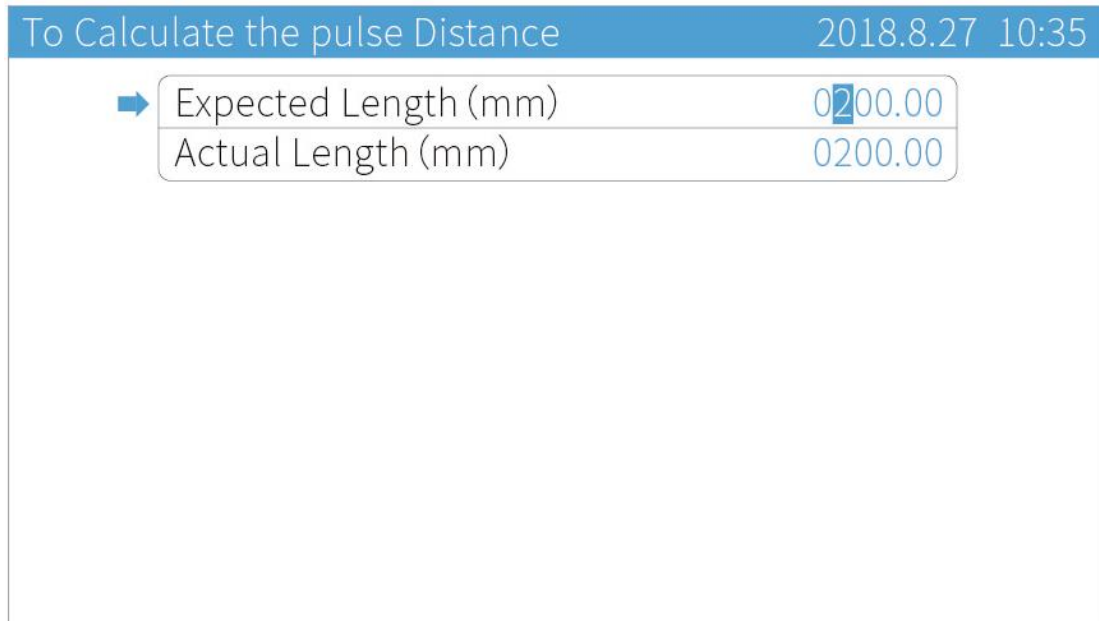

Table7-1-1 X Axis Parameters Instruction

Name	Instruction
Distance Per Pulse (um)	The single distance or angle which the motor moves, when the controller sends a pulse signal. If set incorrectly, the graphics will change.
Valid Pulse Edge	Effective values for driver level to change, Falling Edge or Rising Edge.
Datum Direction	The direction in which the machine moves when reset. If set incorrectly, the axis moves against origin direction.
Key Direction	The direction in which the axis moves when press keys on

	the panel. When set incorrectly, the axis moves opposite direction.
Limit Polarity	The control level that limit switch passes to the control panel. When set incorrectly, the limit will fail. If the limit sensor is NPN, the limit polarity is negative. If the limit sensor is PNP, the limit polarity is positive.
Range(mm)	The working range of machine.
Start Speed (mm/s)	The initial speed at which the axis moves from rest to motion.
Max ACC (mm/s ²)	The maximum acceleration value of the motion axis when the axis increases or decreases speed.
Max Speed (mm/s)	The maximum speed which the motion axis supports.

7.2 Laser Parameters

On the **Manufacture Params Settings** page, move cursor to **【 Laser Parameters】** and press **【Enter】** . Press **【 ↑ 】【 ↓ 】【 ← 】【 → 】【 Z ↑ 】【 Z ↓ 】【 Enter】** to move cursor, press **【 ← 】【 → 】【 Z ↑ 】【 Z ↓ 】【 Enter】** to modify options, press **【 Z ↑ 】【 Z ↓ 】【 Enter】** to modify parameters and press **【Enter】** to save settings.

Figure7-2-1 Laser Parameters Interface

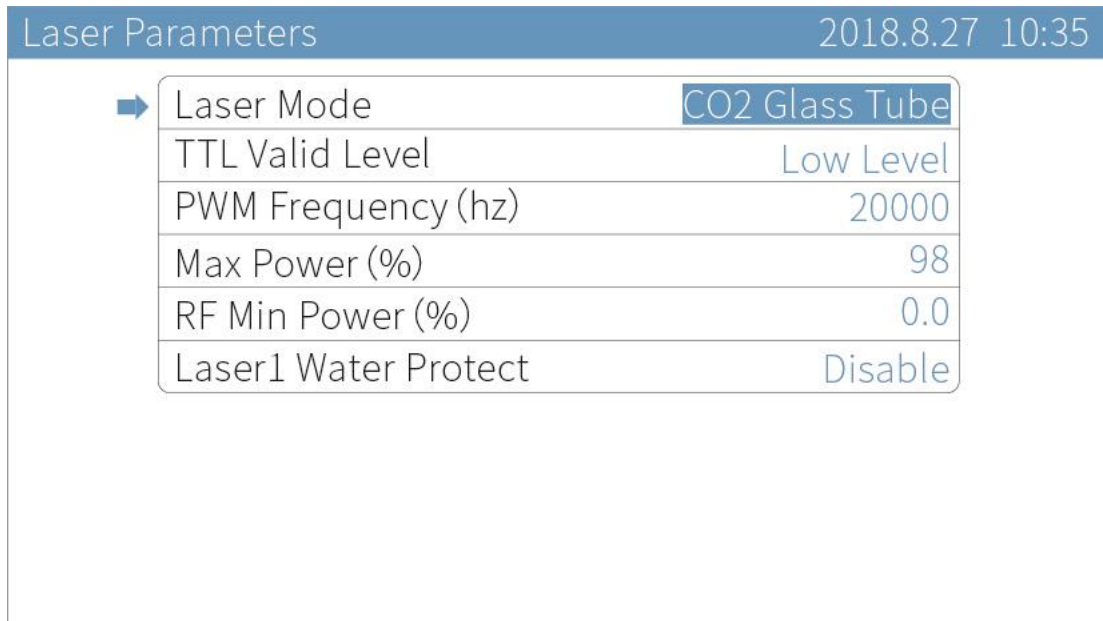

Table7-2-1 Laser Parameters Instruction

Name	Instruction
Laser Mode	Laser tube type: CO2 Glass Tube, RF tube.
TTL Valid Level	The control level of laser tube.
PWM Frequency (Hz)	Set the pulse frequency of control signal used by laser.
Max Power (%)	The maximum power of laser tube. The maximum power value set by user can't be higher than this value and the laser power is displayed as a percentage.
RF Min Power (%)	Turning power.
Laser1 Water Protect	Water protection switch. If enable this function, the machine

	will stop working when the machine detects the signal of water stopping.
--	--

7.3 I/O Parameters

On the **Manufacture Params Settings** page, move cursor to **IO Parameters** and press **Enter** . Press **↑** **↓** to move cursor, press **←** **→** to modify options and press **Enter** to save settings.

Figure7-3-1 I/O Parameters Interface

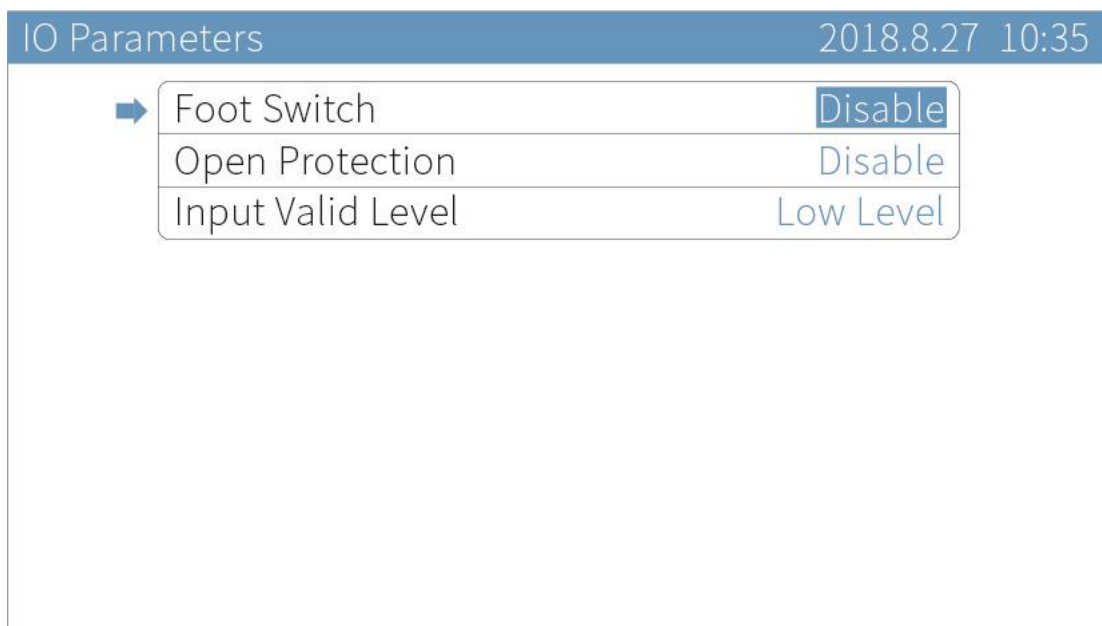

Table7-3-1 I/O Parameters Instruction

Name	Instruction
Foot Switch	Enable or disable the foot switch function.
Open Protection	Enable or disable the open protection function.

Input Valid Level	Set input IO to low level or high level.
-------------------	--

7.4 Auto Reset Settings

On the **Manufacture Params Settings** page, move cursor to **Auto Reset Settings** and press **Enter**. Press **↑** **↓** to move cursor, press **←** **→** to modify options and press **Enter** to save settings.

In general, we suggest users to enable axis AutoReset function.

Figure7-4-1 Auto Reset Setting Interface

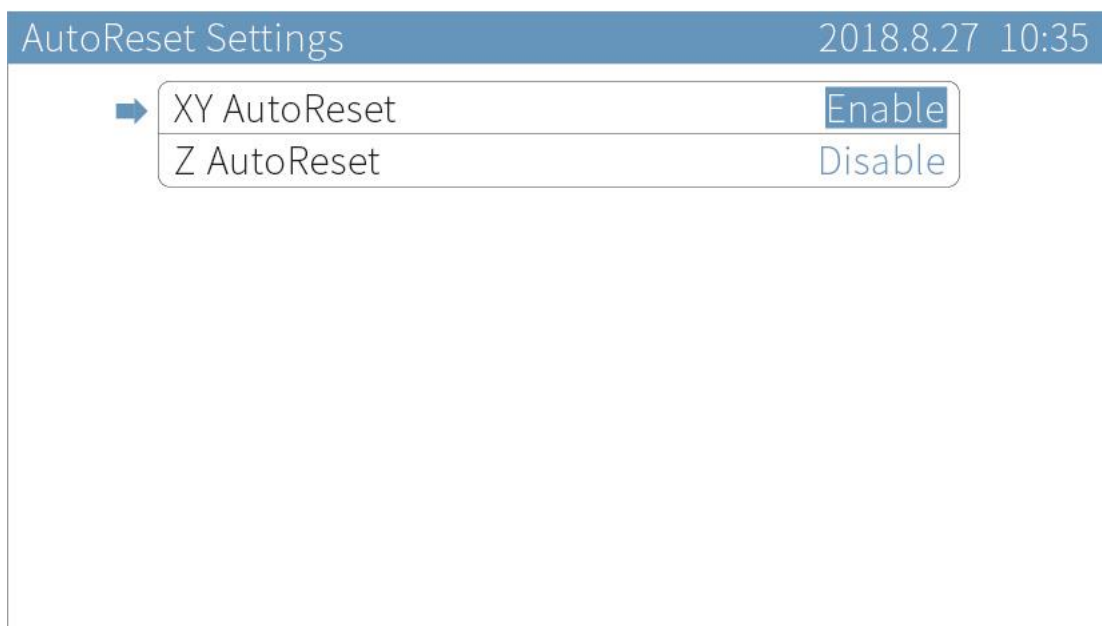

Table7-4-1 Auto Reset Settings Instruction

Name	Instruction
XY Auto Reset	If enable this function, when power on or reset the machine, the XY axis will reset to origin point.

Z Auto Reset	If enable this function, when power on or reset the machine, the Z axis will reset to origin point.
--------------	---

7.5 HardLimit Settings

On the **Manufacture Params Settings** page, move cursor to **【HardLimit Settings】** and press **【Enter】**. Press **【↑】****【↓】** to move cursor, press **【←】** **【→】** to modify options and press **【Enter】** to save settings.

TL-3120 supports working range limit, users do not need to install hard limiter in general, just set the **【Range】** on the axis parameters page.

Figure7-5-1 HardLimit Setting Interface

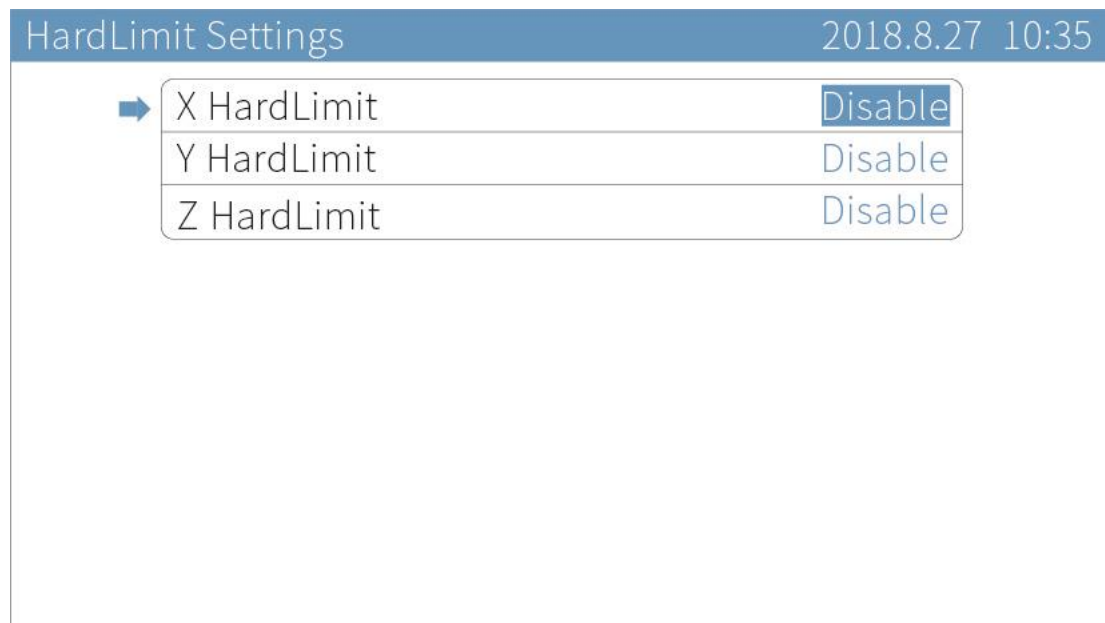

Table7-5-1 Auto Reset Settings Instruction

Name	Instruction
X HardLimit	HardLimit switch of X axis. If use HardLimit, enable the function here.
Y HardLimit	HardLimit switch of Y axis. If use HardLimit, enable the function here.
Z HardLimit	HardLimit switch of Z axis. If use HardLimit, enable the function here.

7.6 Function Config

On the **Manufacture Params Settings** page, move cursor to **Function Config** and press **Enter** . Press **←** **→** to able or disable the **Z-Axis For Autofocus** function and press **Enter** to save settings.

Figure7-6-1 Function Config Interface

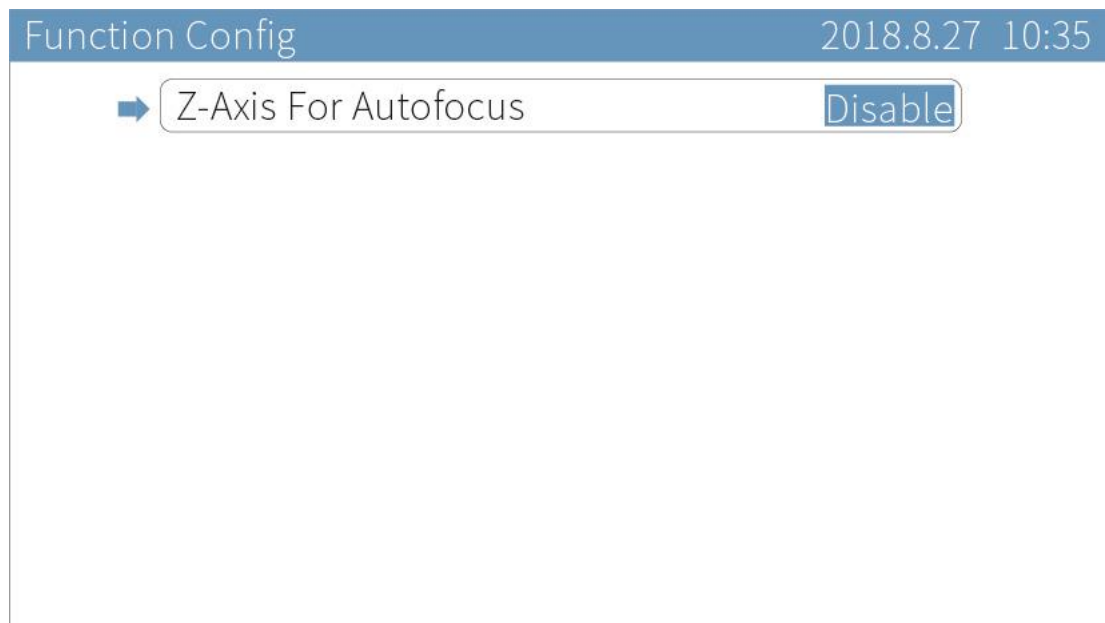

Table7-6-1 Function Config Instruction

Name	Instruction
Z-Axis for Autofocus	The switch of Z-axis Autofocus. If you need Z AutoFocus function, you need to enable this option. This parameter is mainly to control the distance between laser head and working platform.

8. FQA

1. The top bar displays local date and time. The date and time can be modified, which requires the cooperation of encryption software. If the time changes to 0.0.0, it means the battery in the panel has run out of power and can't set password for control card. The clock doesn't support power off relay function.
2. When the file name is in Chinese, it can only show 4 Chinese characters at most, and they are in common Chinese character library. A file name can display up to 8 characters when it uses number or English characters.

Appendix 1: Wiring Diagram of Servo Driver

1. Panasonic A5 High Speed Pulse Wiring Diagram

Figure 1-1 Panasonic A5 High Speed Pulse Wiring Diagram

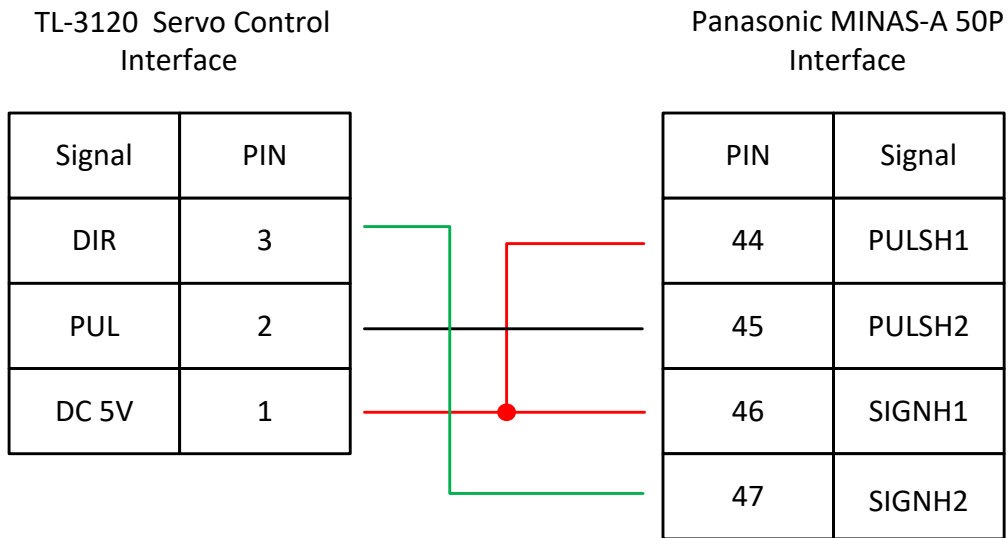

Figure 1-2 Panasonic A5 Low Speed Pulse Wiring Diagram

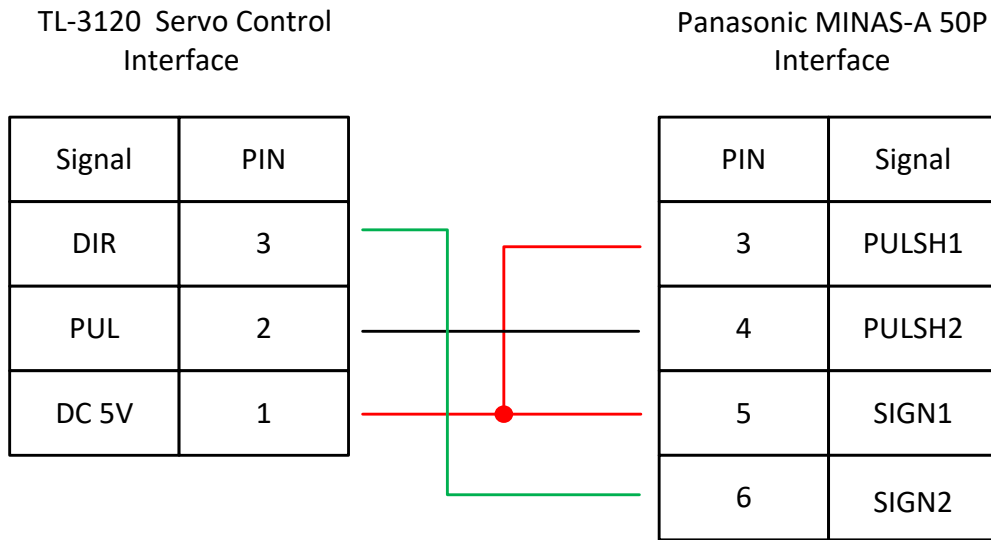

Table1-1 Panasonic A5 Series Basic Setting Parameters

Mode	Value	Instruction
Pr001	0	Control mode, must be set to position mode.
Pr007	3	Must be "Pulse + Direction" mode.
Pr005	1	High-speed pulse connection mode, the parameter is set to "1", and the maximum pulse frequency is 3Mpps. Low speed pulse connection mode, the parameter is set to "0", and the maximum pulse frequency is 500Kpps.

2. Yaskawa Wiring Diagram

Figure 2-1 Yaskawa Wiring Diagram

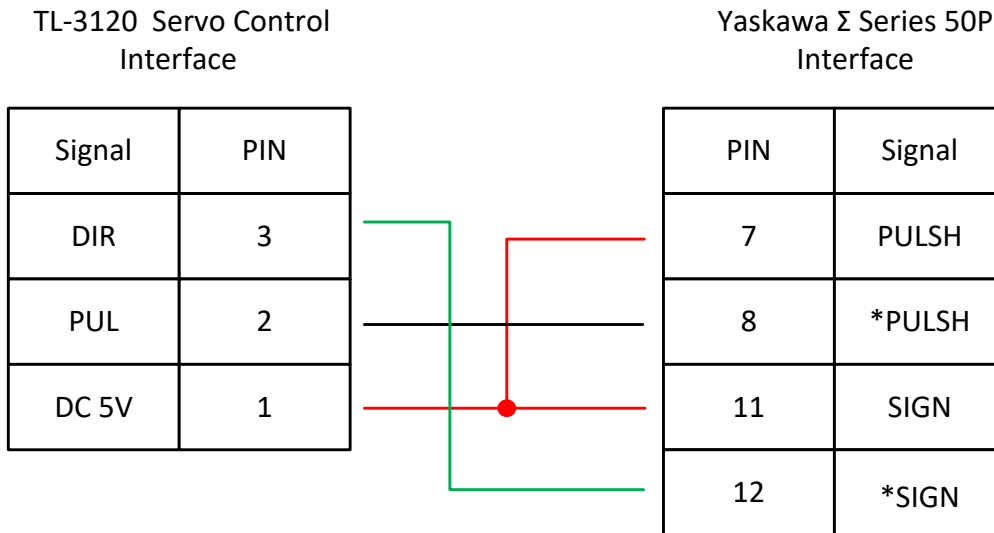

Table2-1 Yaskawa Σ Series Basic Setting Parameters

Mode	Value	Instruction
Pn000	001X	Position mode.
Pn00B	None	When single-phase power input, the parameter is set to "0100".
Pn200	2000H	<p>Positive logic: Pulse + Direction;</p> <p>0005H negative logic: Pulse + Direction;</p> <p>When the pulse frequency is less than 1Mpps, please select "0000H".</p> <p>When the pulse frequency reaches 1Mpps~4Mpps, please select "2000H".</p>

Pn50A	8100	Positive rolling side can be driven.
Pn50B	6548	Negative rolling side can be driven.

3. Delta A Series High Speed Pulse Wiring Diagram

Figure 3-1 Delta A Series High Speed Pulse Wiring Diagram

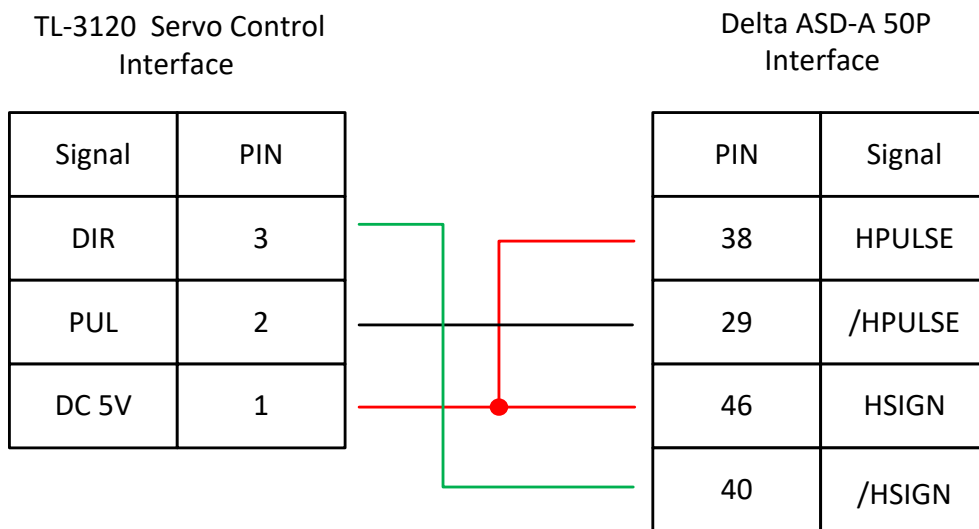

Figure 3-2 Delta A Series Low Speed Pulse Wiring Diagram

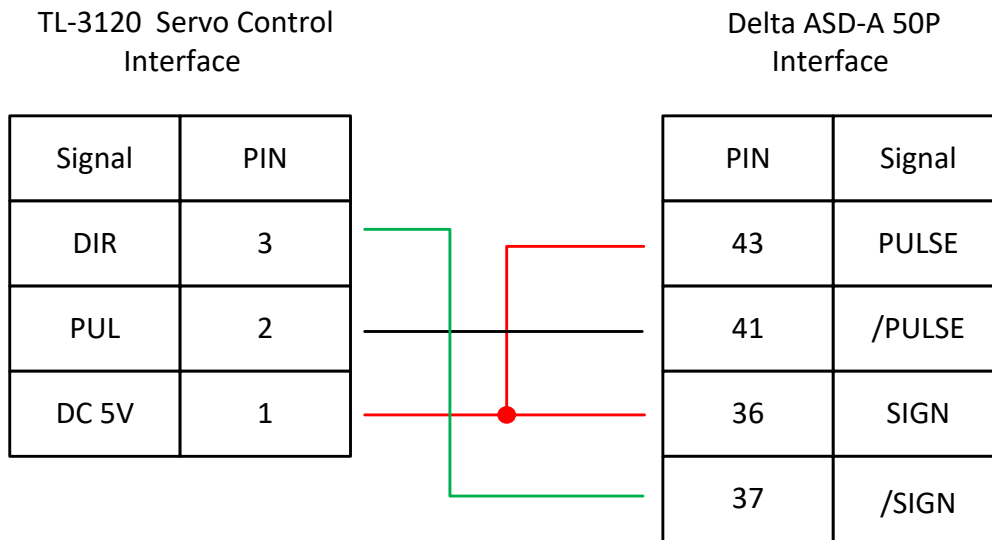

Table3-1 Delta ASD-A Series Basic Setting Parameters

Mode	Value	Instruction
P1-00	1102H	Position control mode, negative logic: "Pulse + Direction". Set the parameter to "1102H" to open the high-speed differential signal, and the maximum pulse frequency is 4Mpps; Set the parameter to "0102H" low-speed pulse signal, and the maximum pulse frequency is 500K.
P1-01	00	Select the location mode controlled by the external instruction.
P2-10	101	DI1 is set to SON servo enablement, and the logic is

		normally open.
P2-14	102	DI5 is set as ARST clear alarm function, the logic is normally open.
P2-12	007	DO5 is set as ALRM servo alarm function, the logic is normally closed.

4. Sanyo R Series Wiring Diagram

Figure 4-1 Sanyo R Series Wiring Diagram

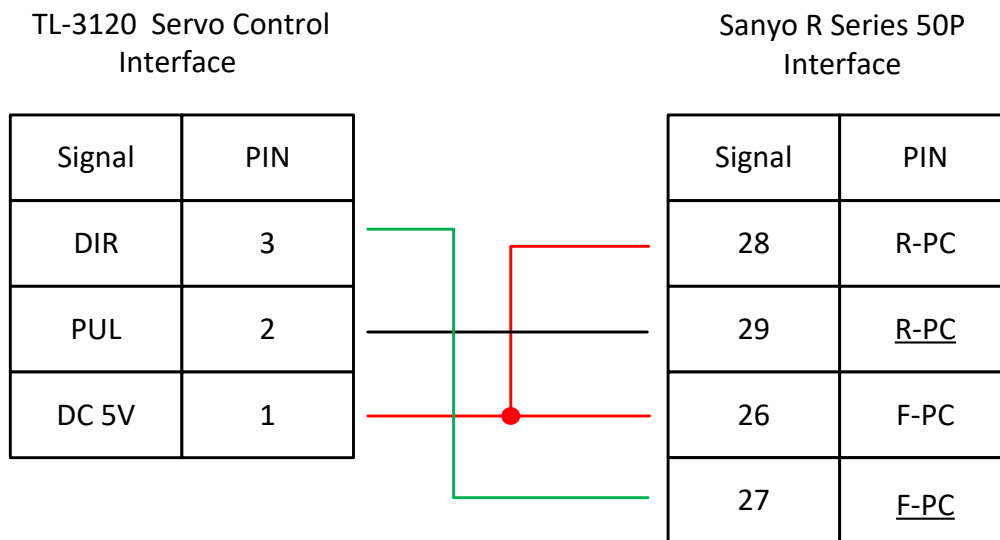

Table4-1 Sanyo R Series Basic Settings Parameters

Mode	Value	Instruction
SY08	00	Position mode.
Gr8.11	02	Pulse signal mode: Pulse + Direction.

Gr9.00	00	Positive rolling side can be driven.
Gr9.01	00	Negative rolling side can be driven.

5. Schneider 23A High Speed Pulse Wiring Diagram

Figure 5-1 Schneider 23A High Speed Pulse Wiring Diagram

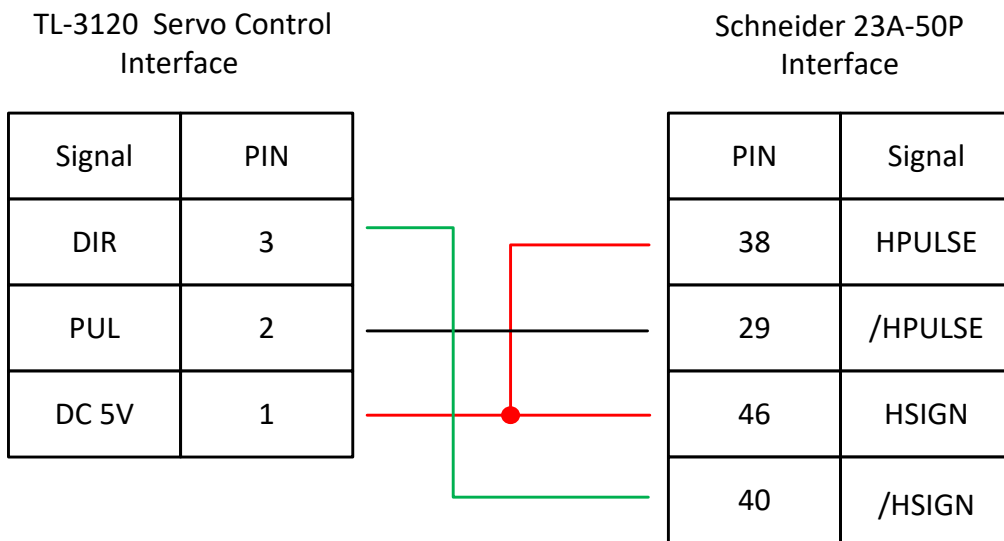

Figure 5-2 Schneider 23A Low Speed Pulse Wiring Diagram

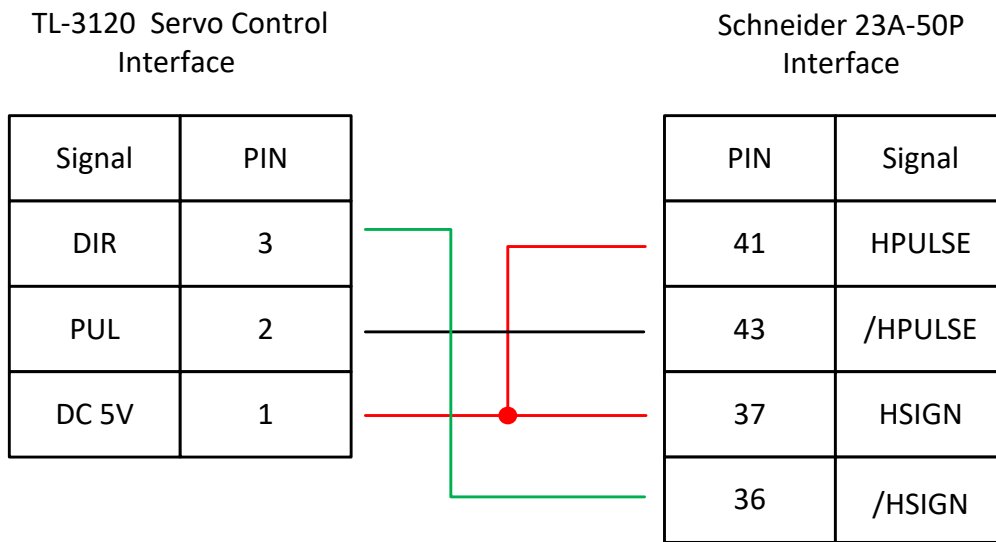

Table5-1 Schneider Lexium 23D Series Basic Settings Parameters

Mode	Value	Instruction
P1-00	1102H	Position control mode, negative logic: "Pulse + Direction". Set the parameter to "1102H" to open the high-speed differential signal, and the maximum pulse frequency is 4Mpps; Set the parameter to "0102H" low-speed pulse signal, and the maximum pulse frequency is 500K.
P1-01	X00	Select the location mode controlled by the external instruction.
P2-10	101	Change the servo IN1 to SON function.

P2-11	0	We do not use IN2。
P2-13~P2-17	0	We do not use IN4~IN8。

6. Fuji A5 Series Wiring Diagram

Figure 6-1 Fuji A5 Series Wiring Diagram

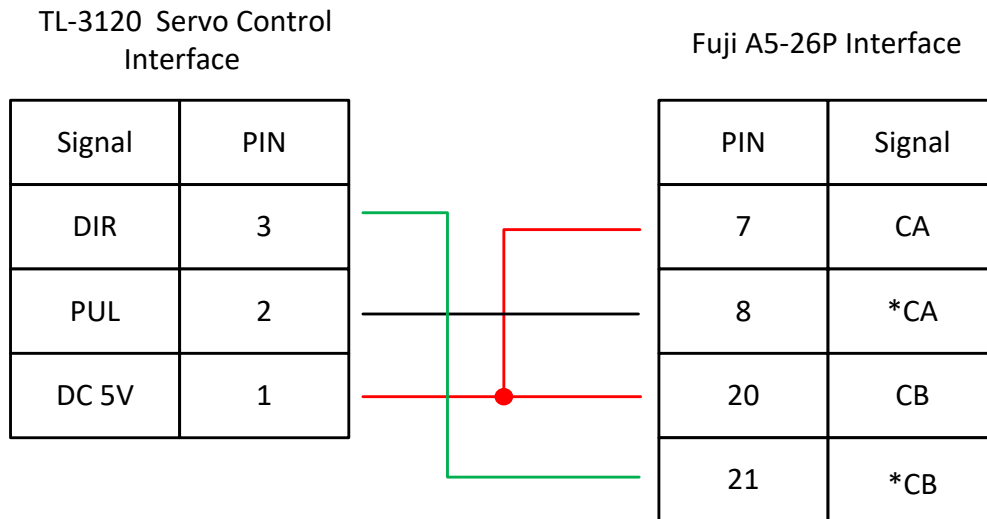

Table6-1 Fuji ALPHA 5 Series Basic Setting Parameters

Mode	Value	Instruction
PA-101	0	Position control mode.
PA-103	0	Pulse + Direction, the maximum pulse frequency is 1Mpps.

7. Mitsu Series Wiring Diagram

Figure 7-1 Mitsu J3 Series Wiring Diagram

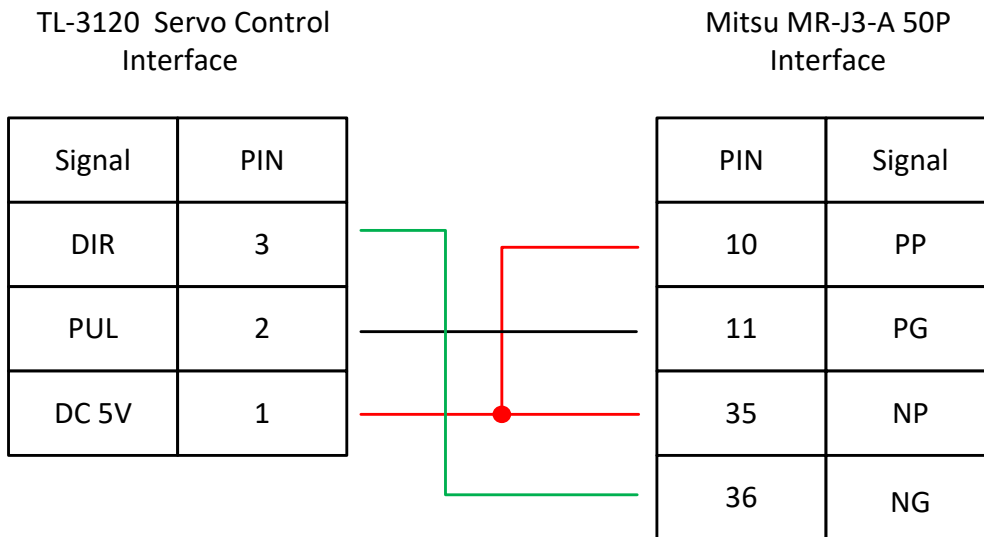

Figure 7-2 Mitsu E Series Wiring Diagram

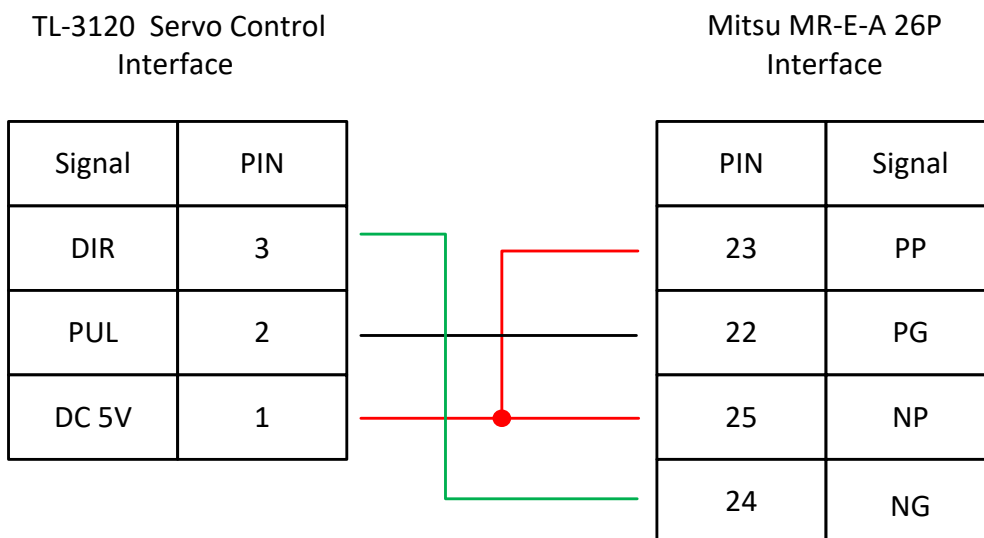

Table7-1 Mitsu MR-J3—A Series Basic Setting Parameters

Mode	Value	Instruction
PA01	0	Control mode: Position mode.
PA13	0011	Negative logic: Pulse + Direction.

Notice: The maximum pulse frequency of Mitsu J3 Series is 1Mpps.